

User Guide

EVGA Classified

Super Record 2 (SR-2)

Dual Xeon

Motherboard

Table of Contents

Before You Begin...	8
Parts NOT in the Kit.....	9
Intentions of the Kit	9
EVGA Classified Super Record 2 (SR-2) Motherboard.....	10
Motherboard Specifications	10
Unpacking and Parts Descriptions	12
Unpacking.....	12
Equipment	12
EVGA Classified SR-2 Motherboard	14
Hardware Installation	18
Safety Instructions	18
Preparing the Motherboard	19
Installing the CPU	19
Installing the CPU Fan.....	20
Installing DIMMs.....	21
Installing the Motherboard	22
Installing the I/O Shield	22
Securing the Motherboard into the Chassis.....	23
Connecting Cables and Setting Switches	24
Power Connections	24
24-pin ATX Power (PW1).....	24
8-pin ATX 12V Power (PW12-P0-1, PW12-P1-1).....	25

Connecting IDE Hard Disk Drives	26
Connecting Serial ATA Cables	27
Connecting Internal Headers	28
Front Panel Header	28
USB Headers	29
Audio Header	30
Fan Connections	31
Expansion Slots	32
PCI-E x16 Slots	33
Onboard Buttons	35
Clear CMOS Button	35
RESET and POWER Button	35
Post Port Debug LED and LED Status Indicators	36
Post Port Debug LED	36
LED Status Indicators	36
Jumper Settings	37
PCI-E Disable Jumper	37
Voltage Measure Point	38
EVGA Control Panel (ECP)	39
Configuring the BIOS	47
Enter BIOS Setup	48
Main Menu	49
Standard BIOS Features Menu	51
System Time/System Date	52
Advanced BIOS Features	53
SATA Configuration	54
AHCI Configuration	54

E-SATA Controller (Back panel).....	54
SATA Configuration.....	55
Advanced Chipset Features.....	56
USB Configuration.....	56
PCI-E Configuration.....	56
PCI/PNP Resource Management.....	58
Clear NVRAM.....	58
Plug & Play O/S.....	58
PCI Latency Timer.....	58
Allocate IRQ to PCI VGA.....	59
Palette Snooping.....	59
PCI IDE Busmaster.....	59
Offboard PCI/ISA IDE Card.....	59
Boot Configuration Features.....	60
Boot Settings Configuration.....	60
Boot Device Priority.....	60
Hard Disk Drives.....	60
Power Management Features.....	61
ACPI Configuration.....	61
Hardware Health Configuration.....	62
H/W HealthFunction.....	62
CPU Fan Mode Setting.....	62
Frequency/Voltage Control.....	62
CPU Configuration.....	63
Memory Configuration.....	63
Voltage Configuration.....	64
Signal Tweaks.....	64

CPU Frequency Setting.....	64
CPU Multiplier Setting.....	64
QPI Frequency.....	64
Memory Frequency.....	65
Installing Drivers and Software	66
Windows XP/Vista/Win7 Drivers Install	66
Appendix A. POST Codes	67
EVGA Glossary of Terms.....	69

List of Figures

Figure 1.	EVGA Classified SR-2 Motherboard Layout	15
Figure 2.	Chassis Back panel Connectors	16
Figure 3.	Power Supply Connectors	24
Figure 4.	Standard BIOS Features Menu.....	51
Figure 5.	Advanced BIOS Features Menu	53
Figure 6.	SATA Configuration.....	55
Figure 7.	Advanced Chipset Features.....	56
Figure 8.	PCI/PNP Resource Management.....	58
Figure 9.	Boot Configuration Features.....	60
Figure 10.	Power Management Features.....	61
Figure 11.	H/W Health Configuration.....	62
Figure 12.	Frequency/Voltage Control.....	63

Before You Begin...

Thank you for purchasing the EVGA Super Record 2 (SR-2) Motherboard.

This is the premier dual socket enthusiast class motherboard.

With this purchase you not only receive the best dual Xeon motherboard built for the enthusiast, by the enthusiast, you also receive industry leading 24/7 technical support. If you ever have any issues we are here to support you and your purchase for the life of the product.

Parts NOT in the Kit

This kit contains all the hardware necessary to install and connect your new EVGA Classified SR-2 motherboard. However, it does not contain the following items that must be purchased separately to make the motherboard functional.

- ❑ **1 or 2 Intel 1366 Xeon Dual QPI microprocessors:**
- ❑ **Cooling fan for each microprocessor**
- ❑ **System memory support**
- ❑ **Graphics Card**
- ❑ **Power Supply**

EVGA assumes you have purchased all the necessary parts needed to allow for proper system functionality.

Intentions of the Kit

This kit provides you with the motherboard and all connecting cables necessary to install the motherboard into a PC case. If you are *building* a PC, you will use most of the cables provided in the kit. If however, you are *replacing* a motherboard, you will not need many of the cables.

When *replacing* a motherboard in a PC case, you will need to reinstall an operating system even if the current drives have an operating system already.

EVGA Classified Super Record (SR-2) Dual Xeon Motherboard

Motherboard Specifications

- ❑ Size
HPTX (High Performance Technology Extended) form factor of 15 inches x 13.6 inches
- ❑ Microprocessor support
Intel 1366 Xeon Dual QPI Microprocessor
- ❑ Operating systems:
Supports Windows XP 32bit/64bit , Windows Vista 32bit/64bit or Windows 7 32bit and 64bit (64bit Recommended)
- ❑ Contains Intel 5520 and ICH10R chipset
- ❑ System Memory support
Supports triple channel DDR3-1600+ (Overclocked). Supports up to 48GBs DDR3 (ECC or Non ECC memory).
- ❑ USB 2.0 Ports
Supports hot plug
Ten USB 2.0 ports (six back panel ports, four onboard USB headers)
Supports wake-up from S1 and S3 mode
Supports USB 2.0 protocol up to 480 Mbps transmission rate
Two USB 3.0 ports (Rear panel)
Backwards compatible USB 2.0 and USB 3.0 support.
Supports up to 4.8Gbps transmission rate

- ❑ Six(6) onboard Serial ATA II
300MBps data transfer rate
Six SATA II connectors from south bridge ICH10R with support for RAID 0, RAID 1, RAID 10, and RAID 5
- ❑ Two (2) SATA II connectors from JMicron JMB362 (two rear panel port for E-SATA,)
- ❑ Two (2) SATA3 600MBps onboard connectors from Marvell 9128 Chipset
- ❑ Onboard LAN
Dual LAN interface built-in onboard marvell 88E8057 chipset.
Supports 10/100/1000 Mbit/sec Ethernet
- ❑ Onboard Audio
Realtek High-Definition audio
Realtek Chipset ALC889
Supports 8-channel audio
Supports S/PDIF output
Supports Jack-Sensing function
- ❑ PCI-E Support
Seven (7) PCI-E 2.0 Slots
Supports 4 GB/sec (8 GB/sec concurrent) bandwidth
Low power consumption and power management features
- ❑ Green Function
Supports ACPI (Advanced Configuration and Power Interface)
Supports S0 (normal), S1 (power on suspend), S3 (suspend to RAM), S4 (Suspend to disk - depends on OS), and S5 (soft - off)

Unpacking and Parts Descriptions

Unpacking

The EVGA Classified SR-2 motherboard comes with all the necessary cables for adding a motherboard to a new chassis. If you are replacing a motherboard, you may not need many of these cables.

Be sure to inspect each piece of equipment shipped in the packing box. If anything is missing or damaged, contact your reseller.

Equipment

The following accessories are included with EVGA Classified - motherboard.



The EVGA Classified SR-2 Motherboard

This motherboard contains the Intel 5520 and ICH10R chipset and is SLI-ready for 2-way, Quad, 3-way, 3-way SLI w/ PhysX and 4-way SLI configurations.



Visual Guide

Helps to quickly and visually guide you through the hardware installation of the motherboard.



I/O Shield

Installs in the system case to block radio frequency transmissions, protect internal components from dust, foreign objects, and aids in proper airflow within the chassis.



3 - 2-Port SATA Power Cables

Allows a Molex power connector to adapt to a SATA power connector.



1 - 4-Port USB Bracket

Provides one (4) additional USB ports on the rear of the case.



6 - SATA Data Cables

Used to support the Serial ATA protocol and each one connects to a single drive to the motherboard.



1 - IDE-ATA 133 HDD Cable

Passes data between the IDE connection on the motherboard and IDE device.



1 - 2-Way SLI Bridge

Bridges two (2) graphic cards together which allows for 2-Way SLI.



1 - 3-Way SLI Bridge

Bridges three (3) graphic cards together which allows for 3-Way SLI.



1 - 4-Way SLI Bridge

Bridges four (4) graphic cards together which allows for 4-Way SLI. (on select card models)



1 - Installation CD

Contains drivers and software needed to setup the motherboard.

EVGA Classified SR-2 Motherboard

The EVGA Classified SR-2 Motherboard with the Intel 5520 and ICH10R chipset is a SLI-ready motherboard. Figure 1 shows the motherboard and Figure 2 shows the back panel connectors.

Figure 1. EVGA Classified SR-2 Motherboard Layout

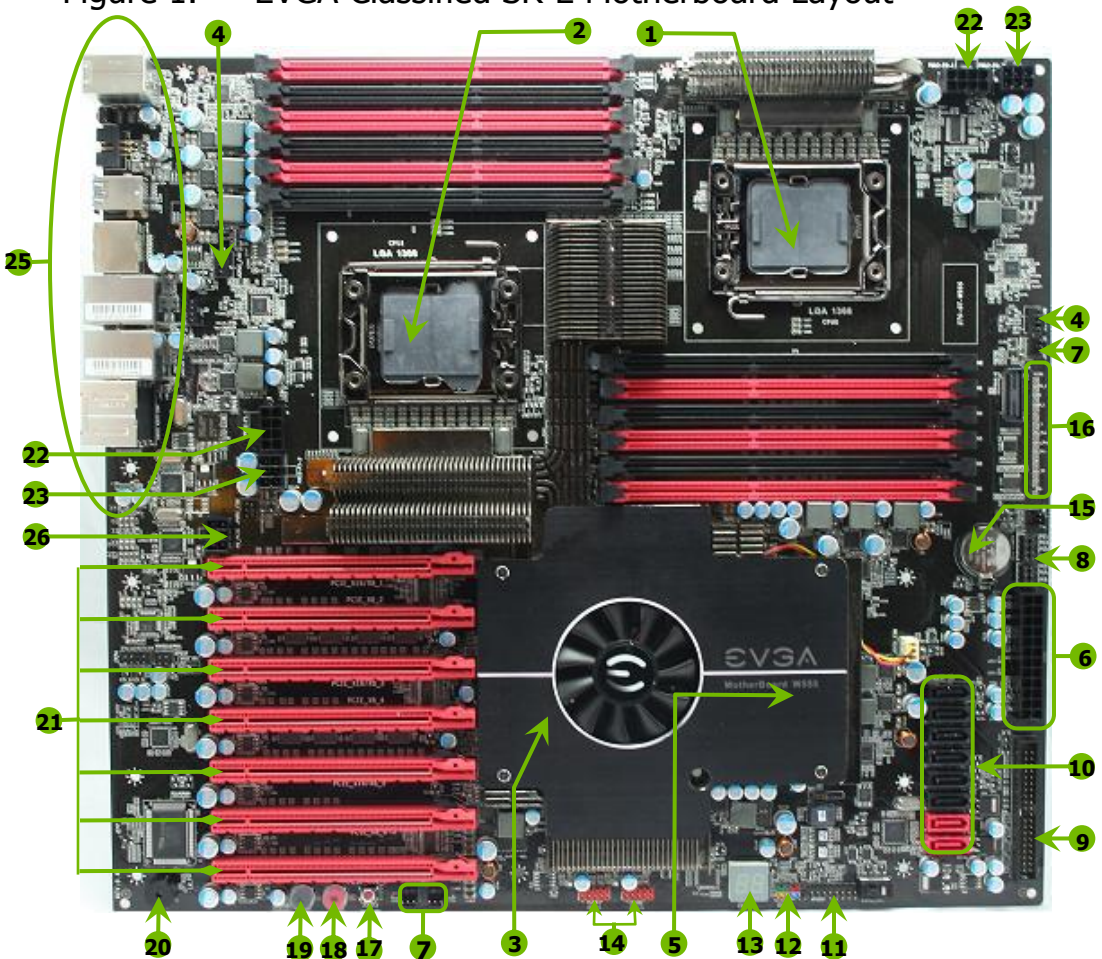

1. Primary CPU socket	11. P80P connector (ECP V3)	21. PCI-E 2.0 slots
2. Secondary CPU socket	12. Front panel connector	22. 8-pin ATX_12V power connector
3. NVIDIA NF200 Chipsets	13. Debug LED Display	23. 6 Pin CPU power (optional)
4. CPU Fan headers	14. USB headers	24. Front panel Audio connector
5. Intel 5520 + ICH10R Chipsets	15. CMOS battery	25. Back panel connectors (Figure 2)
6. 24-pin ATX power connector	16. EZ voltage read points	26. 6 Pin power for PCI-E slots
7. Fan connectors	17. CMOS clear button	
8. PCI-E x16 disable jumpers	18. Power button	
9. IDE connector	19. Reset button	
10. Serial-ATA (SATA) connectors	20. PC Speaker	

Figure 2. Motherboard I/O Panel Connectors

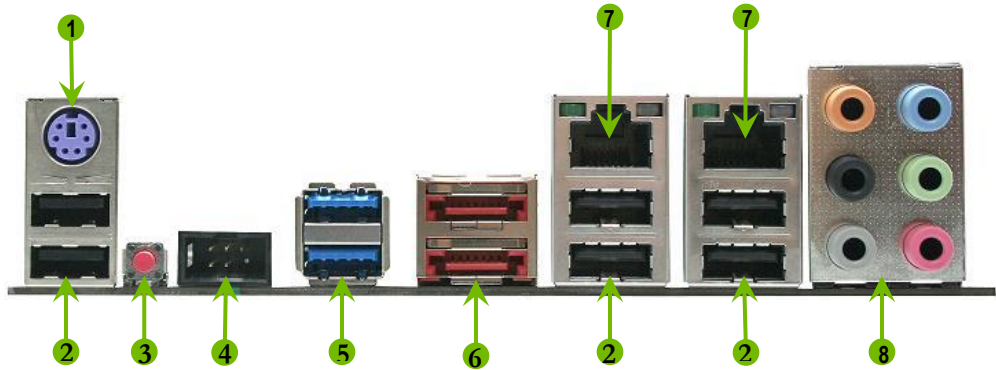

1. PS/2 Keyboard Port
2. USB 2.0 ports
3. CMOS Clear Button
4. EVBot Connector
5. USB 3.0/2.0 ports (Two)
6. E-SATA ports (Two)
7. Dual Lan Ports with LEDs to indicate status

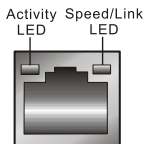

Activity LED Status	Description
Off	No data transmission
Blinking (Green)	Data transmission

Speed/Link LED Status	Description
Yellow	1000 Mbps data rate
Green	100 Mbps data rate
Off	10 Mbps data rate

8. Audio Port	2-Channel	6-Channel	8-Channel
Blue	Line-In	Line-In	Line-In
Green	Line-Out	Front Speaker Out	Front Speaker Out
Pink	Mic In	Mic In	Mic In
Orange		Center/Subwoofer	Center/Subwoofer
Black		Rear Speaker Out	Rear Speaker Out
Gray			Side Speaker Out

Hardware Installation

This section will guide you through the installation of the motherboard. The topics covered in this section are:

- ❑ Preparing the motherboard
- ❑ Installing the CPU's
- ❑ Installing the CPU fans
- ❑ Installing the memory
- ❑ Installing the motherboard
- ❑ Connecting cables

Safety Instructions

To reduce the risk of fire, electric shock, and injury, always follow basic safety precautions.

Remember to remove power from your computer by disconnecting the AC main source before removing or installing any equipment from/to the computer chassis.

Preparing the Motherboard

The motherboard shipped in the box does **not** contain a CPU or memory. You need to purchase these to complete the installation.

Installing the CPU

Be very careful when handling the CPU. Make sure not to bend or break any pins inside the socket. Hold the processor only by the edges and do not touch the bottom of the processor.

Use the following procedure to install the CPU onto the motherboard.**

****Please ensure that with single processor usage you are using CPU socket 0 and the adjacent ram bank.**

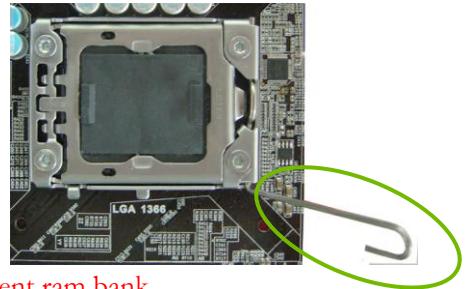

1. Unhook the socket lever by pushing *down* and *away* from the socket.
2. Put your finger on the tail of the load plate and press the tail down
3. Lift the load plate. There is a protective socket cover in the socket to protect the socket when there is no CPU installed.
4. Remove the protective socket cover from the CPU Socket.

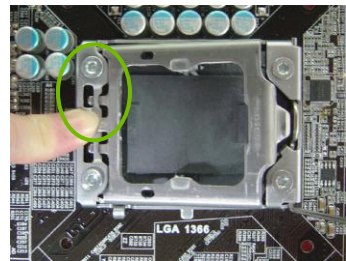

Remove the processor from its protective cover, making sure you hold it only by the edges. It is a good idea to save the cover so that whenever you remove the CPU, you have a safe place to store it.



5. Align the notches of the socket with the notches on the cpu.
6. Lower the processor straight down into the socket without tilting or sliding it into the socket

Make sure the CPU is fully seated and level in the socket.

7. Close the load plate over the CPU and press down while you close and engage the socket lever.
8. The CPU installation is complete.



Align notches with notches on the CPU



Installing the CPU Fan

There are many different fan types that can be used with this motherboard. Follow the instruction that came with your fan assembly. Be sure that the fan orientation is correct for your chassis type and your fan assembly.

Installing DIMMs

Your new motherboard has twelve (12) 240-pin slots for DDR3 DIMMs (ECC or Non ECC). They are arranged in two (2) sets of Six (6) slots each. These slots support 1Gb, 2Gb, and 4Gb DDR3 technology. There must be at least one DIMM slot populated in each bank to ensure normal operation. Use the following recommendations for installing DIMMs. (See Figure 1 on page 16 for the location of the DIMM slots.)

- ❑ **One DIMM:** If using 1 DIMM (**Single Channel**), install into: **DIMM slot 1.**
- ❑ **Two or Four DIMMs:** If using 2 DIMMs (**Dual Channel**), install into: **DIMM slots 1 and 3.** If using 4 DIMMs (**Dual Channel**), install into: **DIMM slots 2, 1, 4, and 3.**
- ❑ **Three DIMMs:** If using 3 DIMMs (**Triple Channel**), install into: **DIMM slots 1, 3 and 5.**
- ❑ **Six DIMMs:** If using more than 4 DIMMs, use: **DIMM slots 2, 1, 4, and 3** then proceed to occupy the following DIMM slots in this order: 6 and 5.

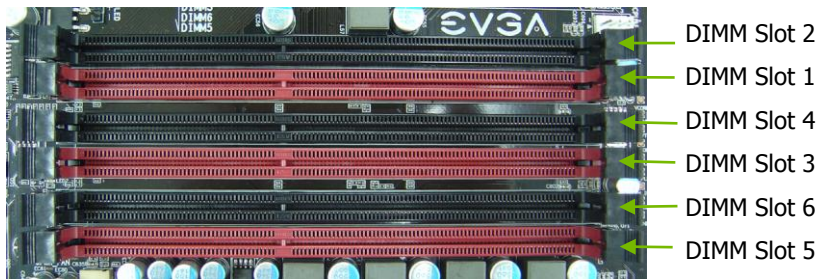

Use the following procedure to install DIMMs. Note that there is only one gap near the center of the DIMM slot. This slot matches the slot on the DIMM to ensure the component is installed properly.

1. Unlock a DIMM slot by pressing the module clips outward.
2. Align the memory module to the DIMM slot, and insert the module vertically into the DIMM slot. The plastic clips at both sides of the DIMM slot automatically lock the DIMM into the connector.

Installing the Motherboard

The sequence of installing the motherboard into the chassis depends on the chassis you are using and if you are replacing an existing motherboard or working with an empty chassis. Determine if it would be easier to make all the connections prior to this step or to secure the motherboard and then make all the connections. It is normally easier to secure the motherboard first.

Use the following procedure to install the I/O shield and secure the motherboard into the chassis.

Be sure that the CPU fan assembly has enough clearance for the chassis covers to lock into place and for the expansion cards. Also make sure the CPU Fan assembly is aligned with the vents on the covers.

Installing the I/O Shield

The motherboard kit comes with an I/O shield that is used to block radio frequency transmissions, protects internal components from dust and foreign objects, and promotes correct airflow within the chassis.

Before installing the motherboard, install the I/O shield from the *inside* of the chassis. Press the I/O shield into place and make sure it fits securely. If the I/O shield does not fit into the chassis, you would need to obtain the proper size from the chassis supplier.

Securing the Motherboard into the Chassis

Most computer chassis have a base with mounting studs or spacers to allow the motherboard to be secured to the chassis and help to prevent short circuits. If there are studs that do not align with a mounting hole on the motherboard, it is recommended that you remove that stud to prevent the possibility of a short circuit. In most cases, it is recommended to secure the motherboard using a minimum of nine (9) spacers.

1. Carefully place the motherboard onto the studs/spacers located inside the chassis.
2. Align the mounting holes with the studs/spacers.
3. Align the connectors to the I/O shield.
4. Ensure that the fan assembly is aligned with the chassis vents according to the fan assembly instruction.
5. Secure the motherboard with a minimum of nine screws.

Connecting Cables and Setting Switches

This section takes you through all the connections and switch settings on the motherboard. This will include:

- ❑ Power Connections
 - 24-pin ATX power (**PW1**)
 - 8-pin ATX 12V power (**PW12-P0-1**, **PW12-P1-1**)
- ❑ Internal Headers
 - Front Panel Header
 - USB Headers
 - Audio Header
- ❑ IDE
- ❑ SATA II/SATA 6Gbps
- ❑ Chassis Fans
- ❑ USB 2.0/3.0
- ❑ Expansion slots
- ❑ CMOS Clear Button
- ❑ Jumper Settings

See Figure 1 on page16. to locate the connectors and jumpers referenced in the following procedure.

24-pin ATX Power (PW1)

PW1 is the main power supply connector located along the edge of the board next to the SATA ports. Make sure that the power supply cable and pins are properly aligned with the connector on the motherboard. Firmly plug the power supply cable into the connector and make sure it is secure.



Board edge

PW1 connector
Plug power cable from system
power supply to PW1

Table 1. PW1 Pin Assignments

Connector	Pin	Signal	Pin	Signal
	1	+3.3V	13	+3.3V
	2	+3.3V	14	-12V
	3	GND	15	GND
	4	+5V	16	PS_ON
	5	GND	17	GND
	6	+5V	18	GND
	7	GND	19	GND
	8	PWROK	20	RSVD
	9	+5V_AUX	21	+5V
	10	+12V	22	+5V
	11	+12V	23	+5V
	12	+3.3V	24	GND

8-pin ATX 12V Power (PW12-P0-1, PW12-P1-1)

PW12-1, PW12-2, the 8-pin ATX 12V power connections, are used to provide power to the CPU. Align the pins to the connectors and press firmly until seated. You can plug in the extra 6 pin PCI-E power connectors (optional) if you need them for extreme overclocking. It is not necessary/required as the motherboard will function perfectly with just one connector in each 8 pin socket.

Back panel connector edge

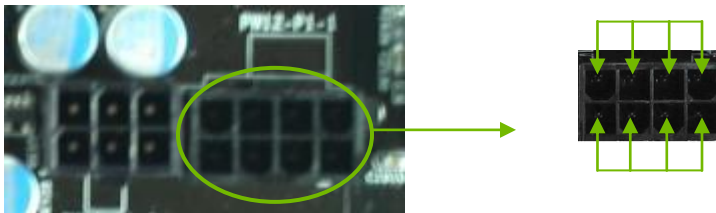

Before installing these plugs be ensure that the 8-pin connector is an ATX 12V differential output, and not a PCI-E power connector.

Connecting IDE Hard Disk Drives

The IDE connector supports Ultra ATA 133/100 IDE hard disk drives.

1. Connect the blue connector (the cable end with a single connector) to the motherboard.
2. Connect the black connector (the cable with the two closely spaced black and gray connectors) to the Ultra ATA master device.
3. Connect the gray connector to a slave device.

If you install two hard disk drives, you must configure the second drive as a slave device by setting its jumper accordingly. Refer to the hard disk documentation for the jumper settings.

If an ATA-100 disk drive and a disk drive using any other IDE transfer protocol are attached to the same cable, the maximum transfer rate between the drives may be reduced to that of the slowest drive.

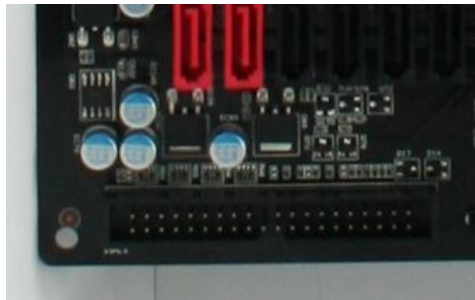

↑
IDE Connector

Board Edge

Connecting Serial ATA Cables

The Serial ATA II connector is used to connect a Serial ATA II device to the motherboard. These connectors support the thin Serial ATA II cables for primary storage devices. The current Serial ATA II interface allows up to 300MB/s data transfer rate.

The two (2) Red ports are SATA 6Gbps spec and support transfer speeds of up to 600MB/s. SATA II drives are compatible but will not see the enhanced SATA 6Gbps performance.

There are eight (8) internal Serial ATA connectors and two (2) E-SATA on this motherboard. Connection points SATA0 - SATA5, are controlled by the South Bridge Chipset. Connection points SATA8 - SATA9 are e-SATA and are controlled by the JMicron JMB362 chip. SATA 6 – SATA 7 are SATA 6Gbps spec and are controlled by the Marvell 9128 Chipset.

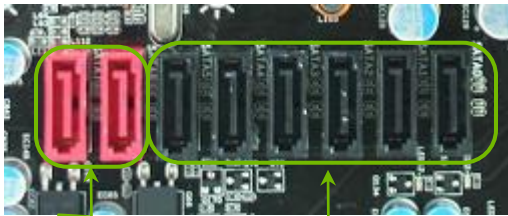

SATA III ports 6/7

SATA 0-5

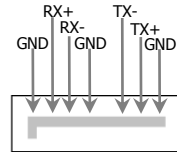

SATA 8/9 (E-SATA)

Connecting Internal Headers

Front Panel Header

The front panel header on this motherboard is used to connect the following four cables.

(see Table 2 for pin definitions):

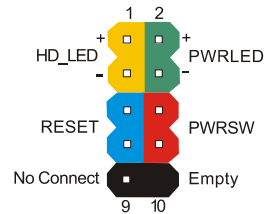

❑ PWRLED

Attach the front panel power LED cable to these two pins of the connector. The Power LED indicates the system's status. When the system is turn on status, the LED is on. When the system is turned on, the LED will be on. When the system is turned off or in S3 status, the LED will be off. When the system is in S1 or S4 status, the LED will be on.

Some chassis do not have all four cables. Be sure to match the name on the connectors to the corresponding pins.

❑ PWRSW

Attach the power button cable from the case to these two pins. Pressing the power button on the front panel turns the system on and off.

❑ HD_LED

Attach the hard disk drive indicator LED cable to these two pins. The HDD indicator LED indicates the activity status of the hard disks.

❑ RESET

Attach the Reset switch cable from the front panel of the case to these two pins. The system restarts when the **RESET** switch is pressed.

Table 2.Front Panel Header Pins

	Pin	Signal
HD_LED	1	HD_PWR
	3	HD Active
PWRLED	2	PWR LED
	4	STBY LED
RESET	5	Ground
	7	RST BTN
PWRSW	6	PWR BTN
	8	Ground
No Connect	9	+5V
Empty	10	Empty

USB Headers

This motherboard contains six (6) USB 2.0 ports that are exposed on the back panel of the chassis. It also supports two (2) USB 3.0 ports on the back panel which can operate at USB 2.0 or USB 3.0 specifications. The motherboard also contains two 10-pin onboard header connectors that can be used to connect an optional external bracket containing two (2) USB 2.0 ports.



1. Secure the bracket to either the front or rear panel of your chassis.
2. Connect the end of the USB cable to the USB 2.0 headers on the motherboard.

Table 3. USB 2.0 Header Pins

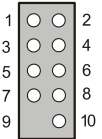
Connector	Pin	Signal
USB 2.0 Header Connector 	1	5V_DUAL
	3	D-
	5	D+
	7	GND
	9	Empty
	Pin	Signal
	2	5V_DUAL
	4	D-
	6	D+
	8	GND
10	No Connect	

Audio Header

The audio connector supports HD audio standard and provides two kinds of audio output choices: the Front Audio, the Rear Audio. The front Audio supports re-tasking function.

Table 4. Front Audio Header

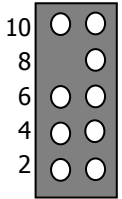
Connector	Pin	Signal
Front Audio Connector 	1	PORT1_L
	2	AUD_GND
	3	PORT1_R
	4	PRECENCE_J
	5	PORT2_R
	6	SENSE1_RETURN
	7	SENSE_SEND
	8	Empty
	9	PORT2_L
	10	SENSE2_RETURN

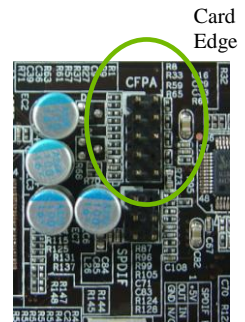

Fan Connections

There are eight fan connections on the motherboard. The fan speed can be detected and viewed on select ports in the PC Health Status section of the CMOS Setup. The fans are automatically turned off after the system enters S3, S4 or S5 mode.

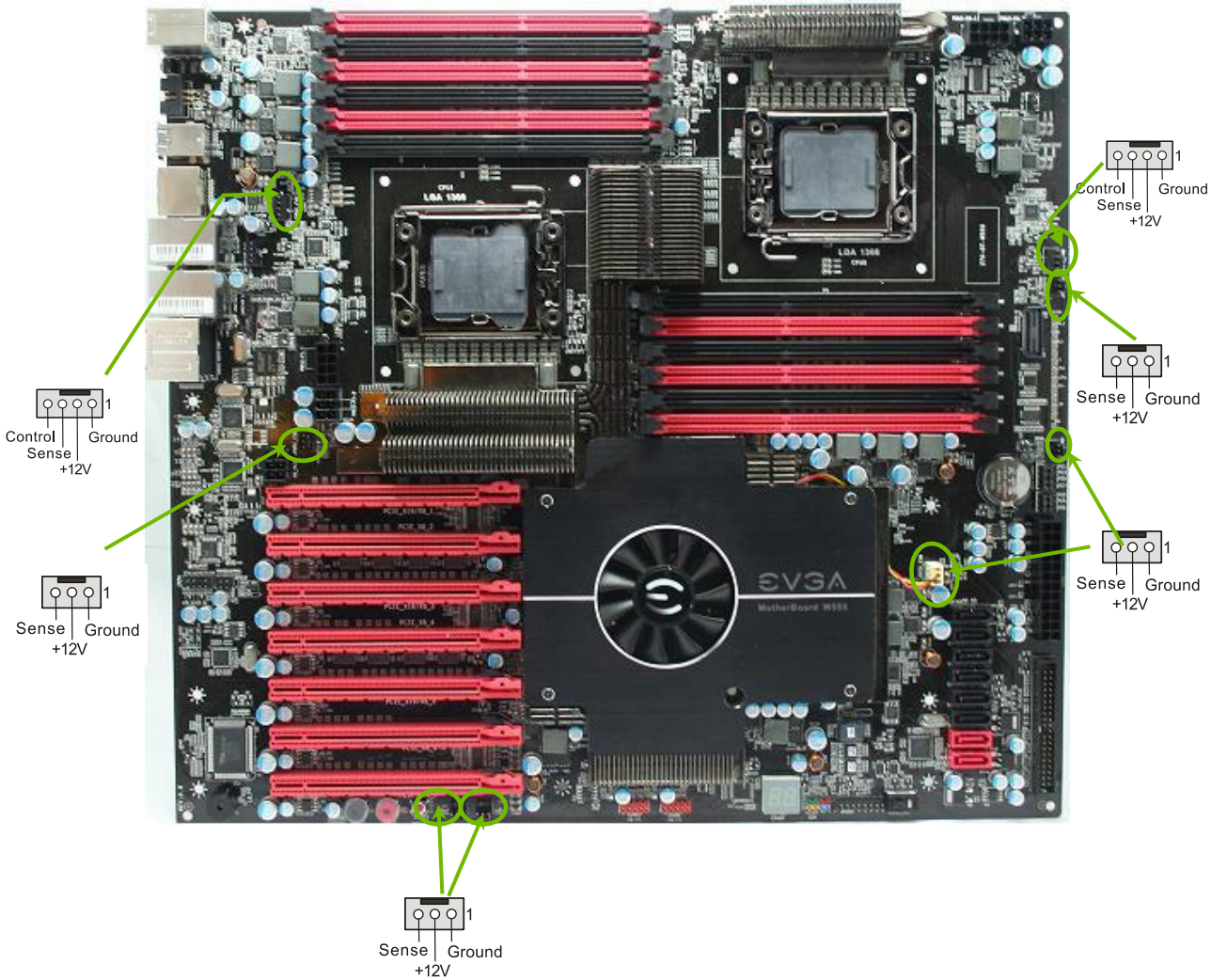

Note: the CPU fan cable can be either a 3-pin or a 4-pin connector. Connect a 3-pin connector to pins 1, 2, and 3 on the CPU fan header.

Expansion Slots

The EVGA Classified SR-2 motherboard contains seven (7) PCI-E expansion slots.

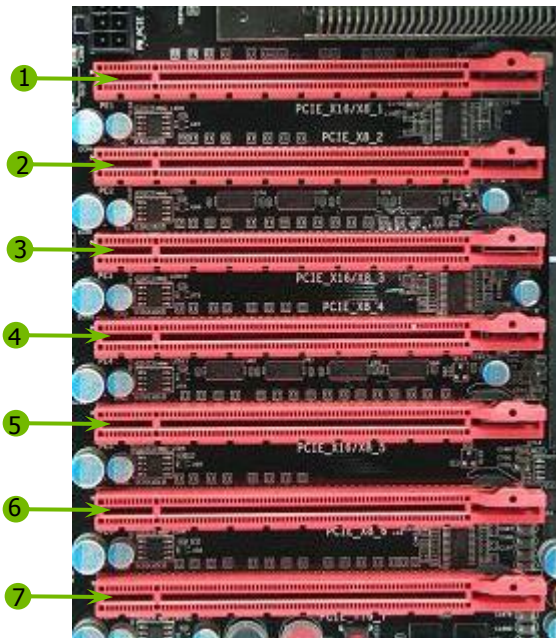

PCI-E Slot Listing

- 1 – PCI-E x16/8 slot
- 2 – PCI-E x8 slot
- 3 – PCI-E x16/8 slot
- 4 – PCI-E x8 slot
- 5 – PCI-E x16/8 slot
- 6 – PCI-E x8 slot
- 7 – PCI-E x16 slot

PCI-E x16 Slots

These seven PCI-E x16/x8 slots are reserved for graphics cards, and x1/x4 devices. The bandwidth of the x16 slot is up to 4GB/sec (8GB/sec concurrent). The design of this motherboard supports up to Four PCI-E graphics cards using NVIDIA's SLI technology with multiple displays.

When installing a PCI-E x16 card, be sure the retention clip snaps and locks the card into place. If the card is not seated properly, it could cause a short across the pins. Secure the card's metal bracket to the chassis with the screw used to hold the blank cover.

Onboard Buttons

These onboard buttons include RESET, POWER and Clear CMOS. These functions allow you to easily reset the system, turn on/off the system, or clear the CMOS.

Clear CMOS Button

The motherboard uses the CMOS to store all the set parameters. The CMOS can be cleared by pressing the Clear CMOS button either onboard or on the rear panel.

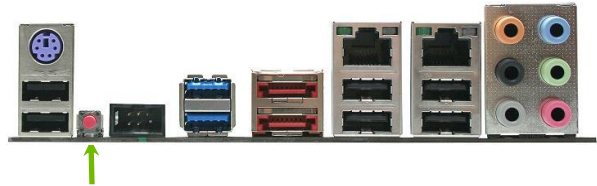

External Clear CMOS Button

RESET and POWER Button

These onboard buttons allow you to easily turn on/off the system. These onboard buttons allow you to easily turn on/off the system and allow for easy debugging and testing of the system during troubleshooting situations.

The POWER button contains a LED that indicates the system's status. When the system is powered on, the LED remains a solid red

The RESET button contains a LED that indicates the activity status of the hard disk drives and will blink accordingly.

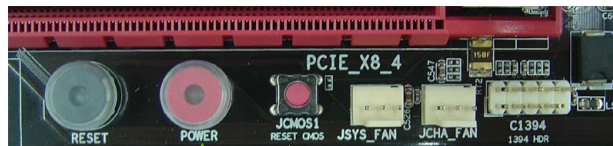

RESET
Button

POWER
Button

Clear CMOS
Button

Post Port Debug LED and LED Status Indicators

Post Port Debug LED

The Debug LED provides two-digit POST codes to show why the system may be failing to boot. It is useful during troubleshooting situations. This Debug LED will also display current CPU temperatures after the system has fully booted into the Operating System.



LED Status Indicators

These LEDs indicate the system's status.

- ❑ POWER LED (Green):
When the system is powered on, the LED is on.
- ❑ DIMM LED (Yellow):
When the memory slot is functional, the LED is on.
- ❑ STANDBY LED (Blue):
When the system receiving power, the LED is on.

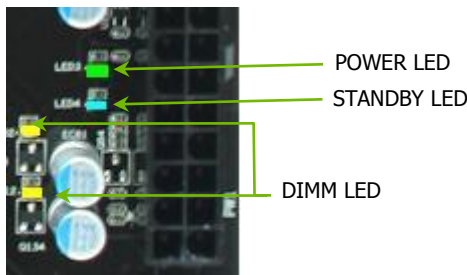

Jumper Settings

PCI-E Disable Jumper

For the ease of troubleshooting multiple graphics cards or testing an individual graphics card's overclocking, EVGA has implemented seven jumpers you can use to disable individual PCI-E slots. You don't need to remove any of your graphics cards but simply disable the slot the particular card is in.

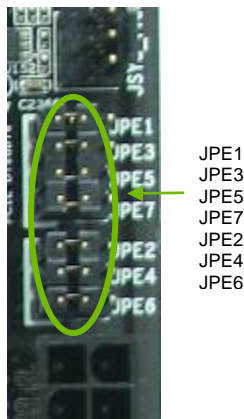

You see the location of the 7 jumpers in the above diagram. They are located right above the 24-pin ATX Connector. In default shipping configurations, all slots are enabled with the jumpers in the left position. From top to bottom, PCI-E slots 1, 3, 5, 7, 2, 4, 6 respectively. To disable a PCI-E lot, move the jumper over to the right position.

Example: Remove the Jumper cap of JPE2, PCI-E Slot 2 is disabled while the rest are enabled. The PCI-E Disable Function can also be extended onto the EVGA Control Panel (ECP).

Do this when the PC is turned off, NOT while it is running!

CPU Disable Jumper

For the ease of troubleshooting Dual CPUs or testing an individual CPU's overclocking, EVGA has implemented two jumpers you can use to disable individual CPUs. You don't need to remove any of your CPUs but simply disable the particular CPU.

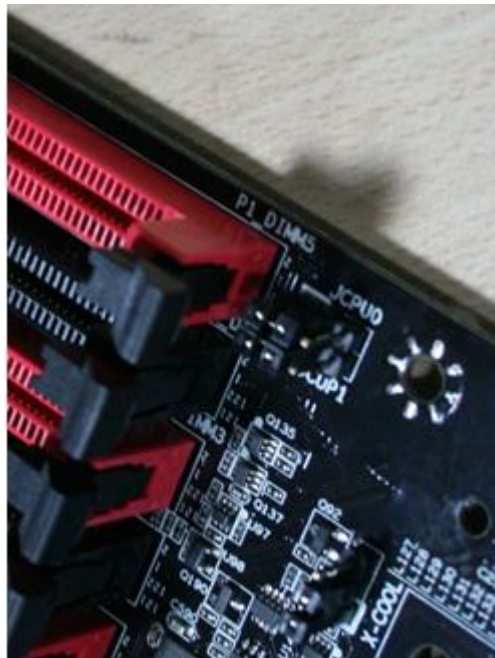

You see the location of the 2 jumpers in the above diagram. They are located at the middle top of the Motherboard. In default shipping configurations, all CPUs are enabled with the jumpers in the left position. CPU0 Jumper is on top while CPU1 Jumper is below. To disable a CPU, move the jumper over to the right position.

Example: Remove the Jumper cap of CPU0, CPU0 is disabled while CPU1 is enabled. The CPU Disable Function can also be extended onto the EVGA Control Panel (ECP).

Do this when the PC is turned off, NOT while it is running!

Voltage Measure Point

The motherboard is equipped with thirteen voltage measure point pads. You can use a meter to measure the voltage at each pad.

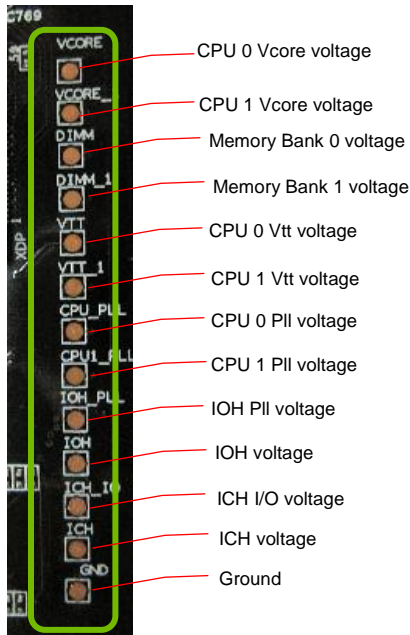

EVGA Control Panel (On select models)

For the convenience of users, EVGA has designed an easy to access control panel:

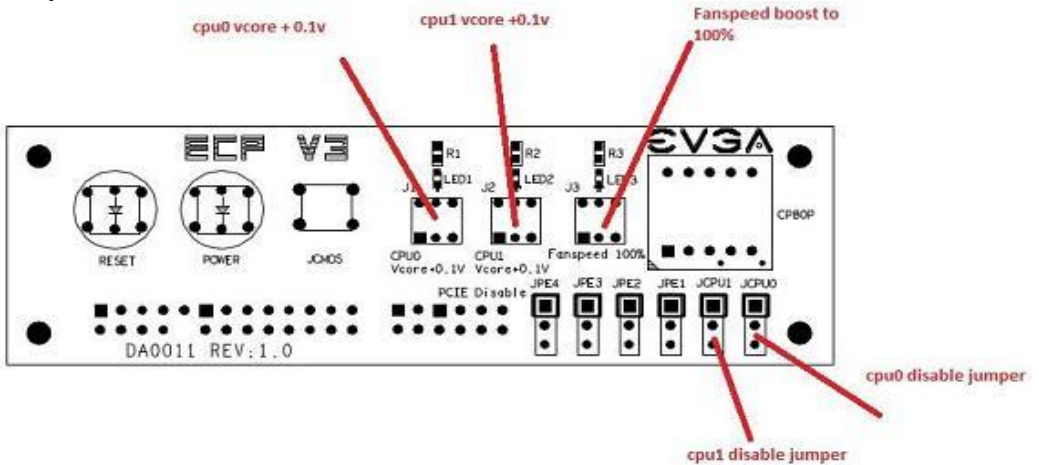

To use the ECP, simply hook up the black ECP cable to the motherboard's P80P connector at this location, the bottom right corner:

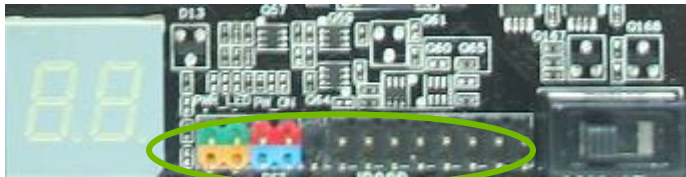

The cable should fit into the area high-lighted in green. It doesn't matter which end of the cable is used. The cable header is designed so that there is only one direction the cable can be connected to the header.

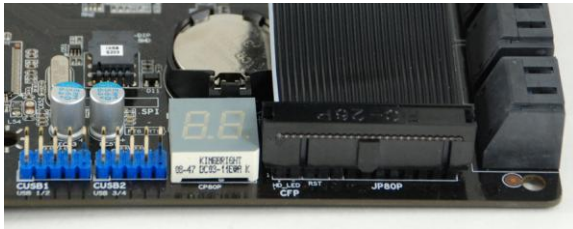

The other end of the cable should be connected to the ECP as shown:

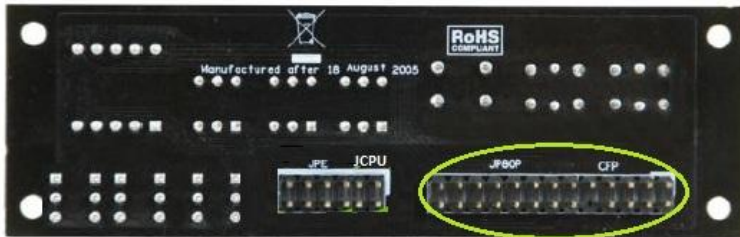

****Before turning on the PC, please check to see that the CPU VCore Booster is in the Off position (clicked up).****

If you wish to access the PCI-E Disable Function via the ECP, please follow these instructions.

Locate the PCI-E disable jumpers below:

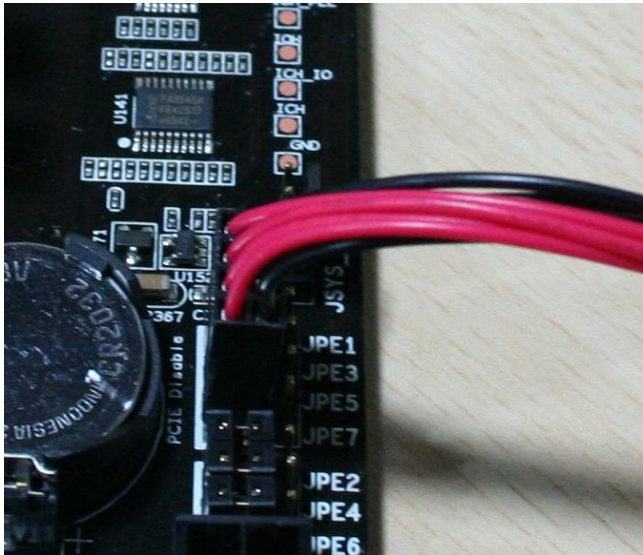

Remove the top 4 jumpers.

Connect the PCI-E cable with the red wires occupying the left most pins:

Please remember to do this when the PC is not running.

Next, connect the other end of PCI-E enable/disable cable onto the ECP as shown:

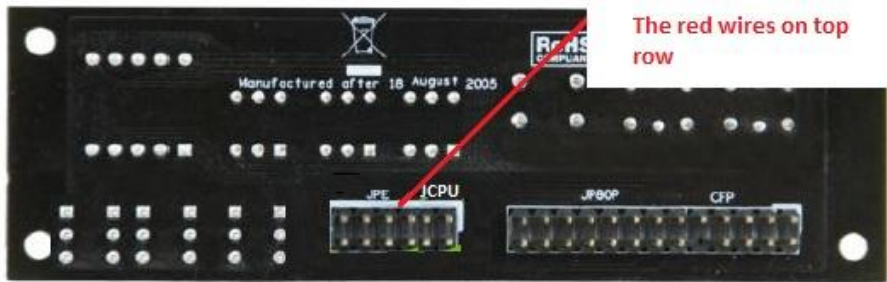

The red wires should be occupying the pins on the top row.

Now, access the Disable/Enable Function at the front of the Control Panel:

From right to left, the PCI-E Disable will disable slots 1, 3, 5, 7. When jumper is in top position, PCI-E slot is enabled. When in bottom position PCI-E slot is disabled.

CPU Disable Jumper

To extend the CPU Disable function to the ECP:

Locate this top part of the Motherboard:

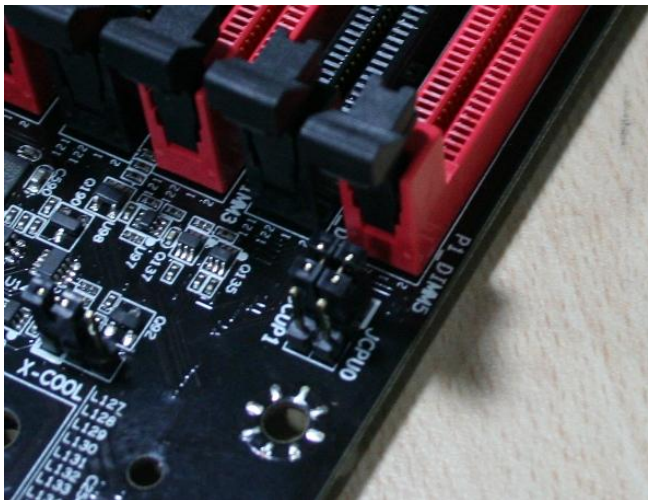

Remove the 2 jumpers.

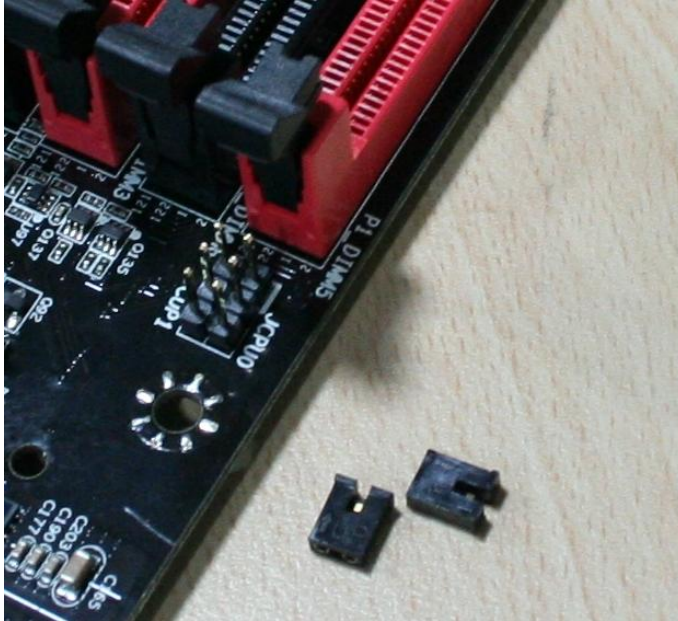

Connect the remaining 3x2 cable connector here, with the red wires on the top row:

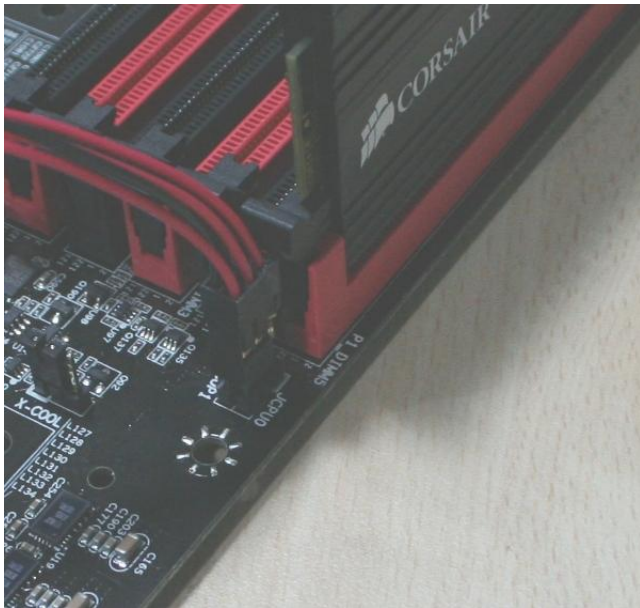
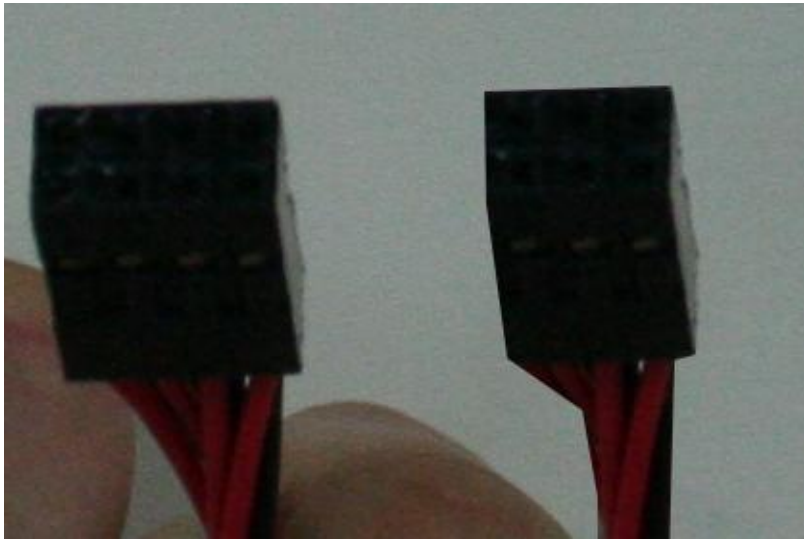

Now, access the Disable/Enable Function at the front of the Control Panel:

From right to left, the CPU Disable jumpers will disable CPU0, CPU1. When jumper is in top position, CPU is enabled. When in bottom position CPU is disabled.

CPU VCore Booster

For convenience of users when overclocking, the ECP houses 2 CPU VCore Boosters for real-time boost of CPU VCore. Each button boosts the VCore by +0.1v to its respective CPU. The last or 3rd button in line is a fan boost to 100% when depressed.

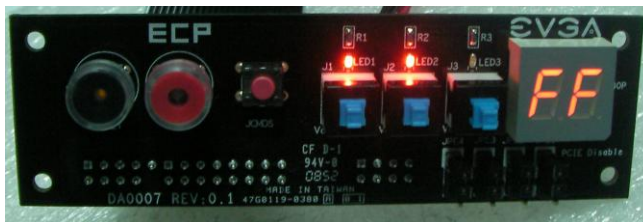

The red LED will light up when VCore booster is pressed. When one red LED is lit, VCore is boosted by +0.1v for that CPU. When 2 red LEDs are lit, VCore is boosted by +0.1v to both CPU's. To disable the VCore boost, just press again and VCore will go down to what you have set in the BIOS.

100% fan speed

The third button is the 100% fan speed button. When pressed it will run all BIOS controlled fans at full speed effectively bypassing any automatic fan control.

Configuring the BIOS

This section discusses how to change the system settings through the BIOS Setup menus. Detailed descriptions of the BIOS parameters are also provided.

This section includes the following information:

- ❑ Enter BIOS Setup
- ❑ Main Menu
- ❑ Standard BIOS Features
- ❑ Advanced Chipset Features
- ❑ PCI/PNP Resource Management
- ❑ Boot Configuration Features
- ❑ Power Management Features
- ❑ Hardware Health Configuration
- ❑ Frequency/Voltage Control

Enter BIOS Setup

The BIOS is the communication bridge between hardware and software. Correctly setting the BIOS parameters is critical to maintain optimal system performance.

Use the following procedure to verify/change BIOS settings.

1. Power on the computer.
2. Press the **Del** key when the following message briefly displays at the bottom of the screen during the Power On Self Test (POST).

Press F1 to continue, DEL to enter Setup.

Pressing **Del** takes you to the American Megatrends BIOS CMOS Setup Utility.

It is *strongly* recommended that you do not change the default BIOS settings. Changing some settings could damage your computer.

Main Menu

The main menu allows you to select from the list of setup functions and two exit choices. Use the **Page Up** and **Page Down** keys to scroll through the options or press **Enter** to display the associated submenu. Use the **↑↓** arrow keys to position the selector on the option you choose to modify. To go back to the previous menu, press **Esc**.

Note that on the BIOS screens all data in **white** is for information only, data in **yellow** is changeable, data in **blue** is non-changeable, and data in a **red box** is highlighted for selection.

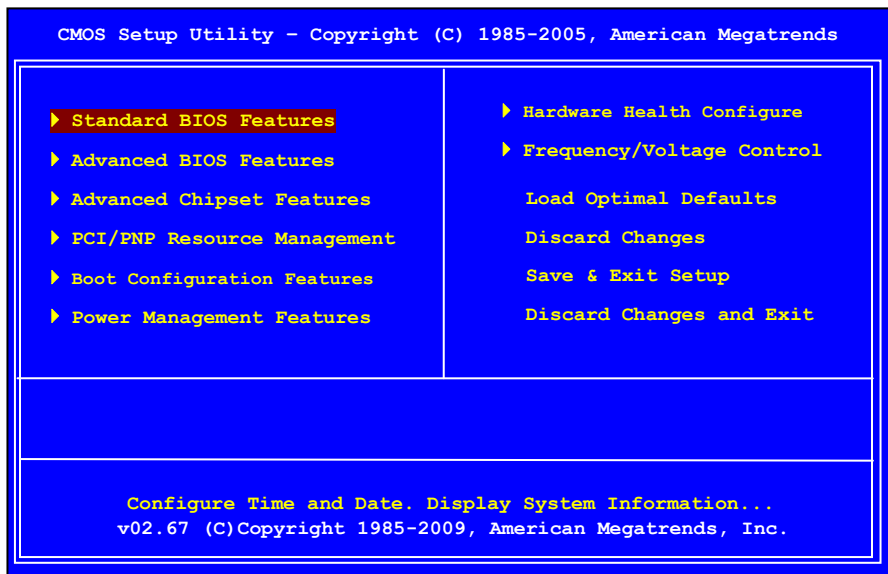

Figure 3. BIOS CMOS Setup Utility Main Menu

□ Standard BIOS Features

Use this menu to set up the basic system configuration.

- ❑ **Advanced BIOS Features**
Use this menu to set up the advanced onboard features such as SATA and USB 3.0 configuration..
- ❑ **Advanced Chipset Features**
Use this menu to set up onboard peripherals such as USB, LAN, and MAC control.
- ❑ **PCI/PNP Resource Management**
Use this menu to configure power management, power on, and sleep features.
- ❑ **Boot Configuration Features**
Use this menu to modify the system's Plug-and-Play and PCI configurations.
- ❑ **Power Management Features**
Use this menu to configure power management, power on, and sleep features
- ❑ **Hardware Health Configuration**
Use this menu to monitor the real-time system status of your PC, including temperature, voltages, and fan speed.
- ❑ **Frequency/Voltage Control**
Use this menu to optimize system performance and configure clocks, voltages, memory timings, and more.

The following items on the CMOS Setup Utility main menu are commands rather than submenus:

- ❑ **Load Optimal Defaults**
Load default system settings.
- ❑ **Discard Changes**
Use this command to discard any changes you have made and not saved during the existing session
- ❑ **Save Changes and Exit**
Use this command to save settings to CMOS and exit setup.
- ❑ **Discard Changes and Exit**
Use this command to abandon all setting changes and exit setup.

Standard BIOS Features Menu

The Standard BIOS Features menu is used to configure the standard CMOS information, such as the date, time, and so on. Use the **+** and **-** keys to scroll through the options. Use the **↑↓** arrow keys to position the selector on the option you choose to modify. To go back to the previous menu, press **Esc**.

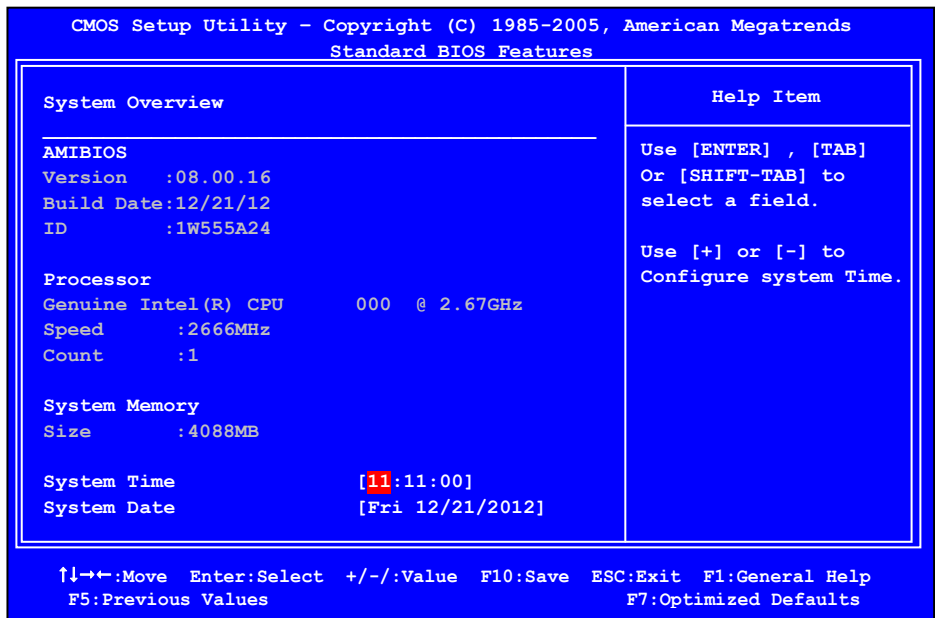

Figure 4. Standard BIOS Features Menu

System Time / System Date

Using the arrow keys, position the cursor over the month, day, and year. Use the + and - keys to scroll through dates and times. Note that the weekday (Sun through Sat) cannot be changed. This field changes to correspond to the date you enter. Note that the hour value is shown in a 24-hour clock format. Time is represented as `hour : minute : second`.

```
System Time      [11:11:00]
System Date      [Fri 12/21/2012]
```

Advanced BIOS Features Menu

Access the Advanced BIOS Features menu from the CMOS Setup Utility screen. Use the **+** and **-** keys to scroll through the options or press **Enter** to display the sub-menu. Use the **↑↓** arrow keys to position the selector on the option you choose to modify. To go back to the previous menu, press **Esc**.

The options that have associated sub-menus are designated by a **▶**, which precedes the option. Press **Enter** to display the sub-menus.

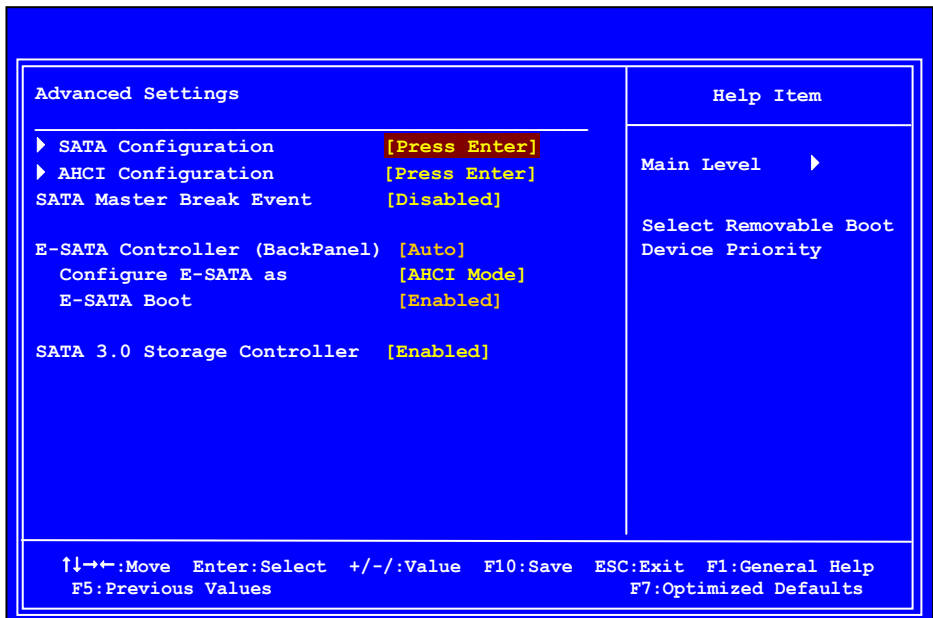

SATA Configuration

Use this to configure your storage drivers and to enable RAID or switch between IDE and AHCI mode. Please note for Windows Vista / Windows 7, it is recommended to use AHCI mode for new system installations.

AHCI Configuration

This menu will allow you to change advanced AHCI settings, such as S.M.A.R.T. status and more.

E-SATA Controller (Back panel)

This option allows you to enable or disable the IO panel E-SATA ports.

SATA Configuration

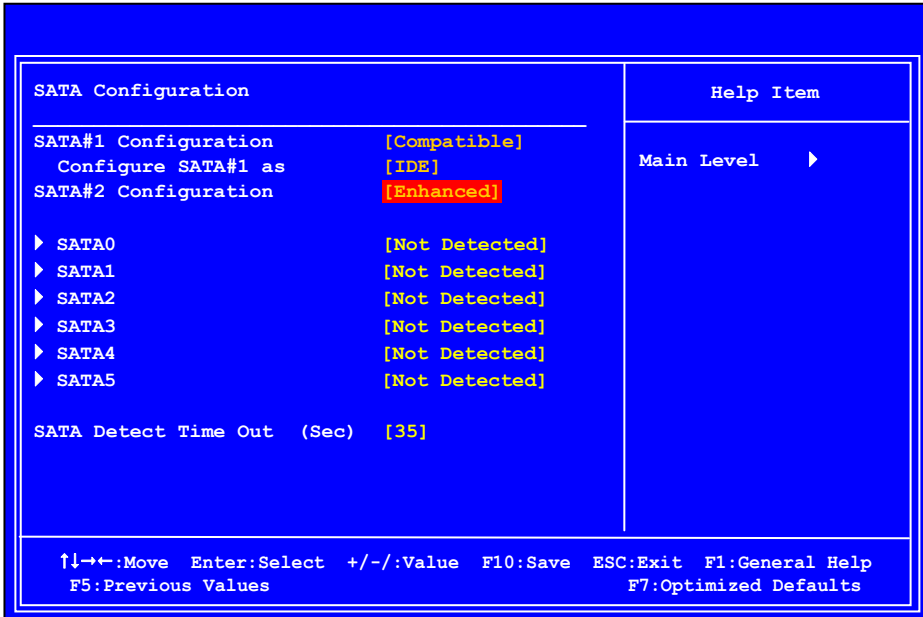

SATA#1 Configuration

This option allows setup of SATA #1, your options are: Disable, Compatible and Enhanced

Configure SATA#1 as

This option allows Setting of SATA mode. Your options are: IDE, RAID and AHCI.

SATA#2 Configuration

This option allows setup of SATA #1, your options are: Disable and Enhanced

Advanced Chipset Features

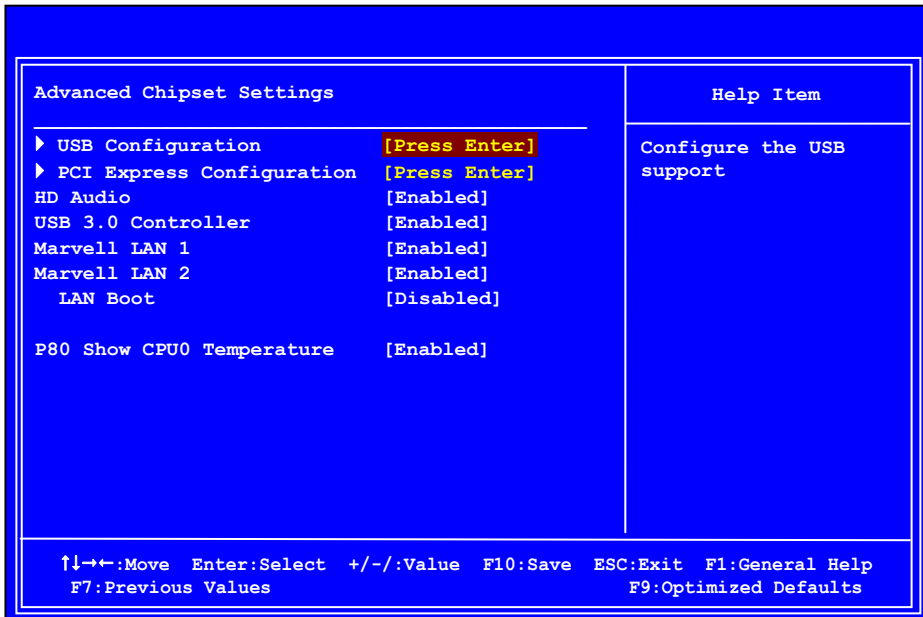

USB Configuration

This option menu allows you to enable Legacy USB support, force USB 1.1 mode and more.

PCI-E Configuration

This option menu will allow you to set advanced PCI-E options, such as Payload size. It is not recommended to adjust these settings.

❑ **HD Audio**

Use this function to set the onboard audio function. It is recommended to leave this enabled, unless you are using a different audio solution.

❑ **Marvell LAN 1**

This function allows you to enable or disable the onboard primary network controller. It is recommended to leave this enabled, unless you are using an external Network Controller, such as an EVGA Killer Xeno card.

❑ **Marvell LAN 2**

This function allows you to enable or disable the onboard secondary network controller. It is recommended to leave this enabled, unless you are using an external Network Controller, such as an EVGA Killer Xeno card.

❑ **P80 Show CPU0 Temperature**

When this function is enabled the onboard Post Port LED will display the CPU0 (primary) temperature.

PCI/PnP Resource Management

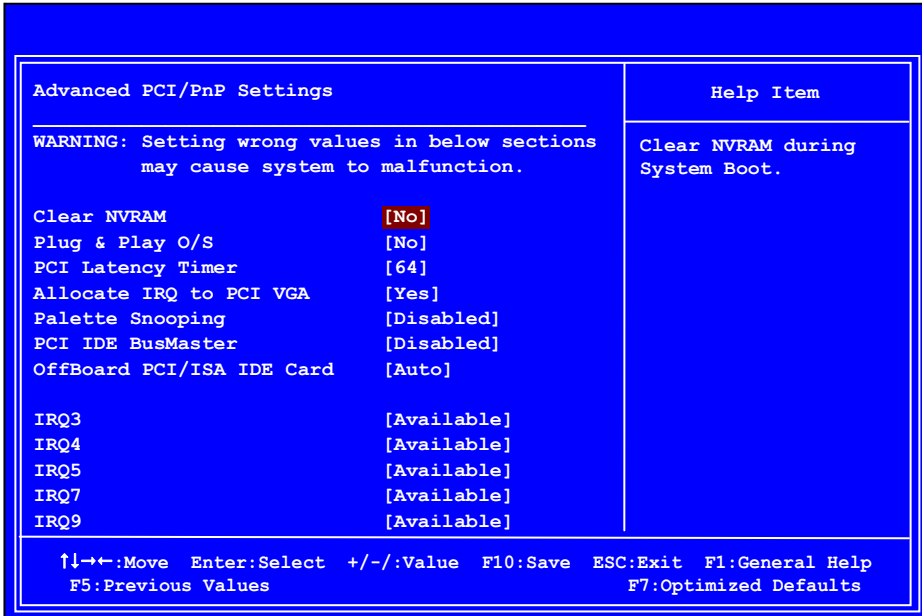

Clear NVRAM

This function clears the NVRAM during System Boot.

Plug & Play O/S

This function sets whether the O/S or BIOS configures Plug and Play devices. A setting of [No] is default.

PCI Latency Timer

This function sets the value in units of PCI clocks.

Allocate IRQ to PCI VGA

This function allows an IRQ to be assigned to a PCI VGA.

Palette Snooping

This function allows the BIOS to inform the system that an ISA graphics device is installed.

PCI IDE BusMaster

This function allows the BIOS to use PCI BusMastering for reading or writing to IDE drives.

OffBoard PCI/ISA IDE Card

This function allows manual override of PCI/ISA external cards. A setting of [Auto] works for most devices.

Boot Configuration Features

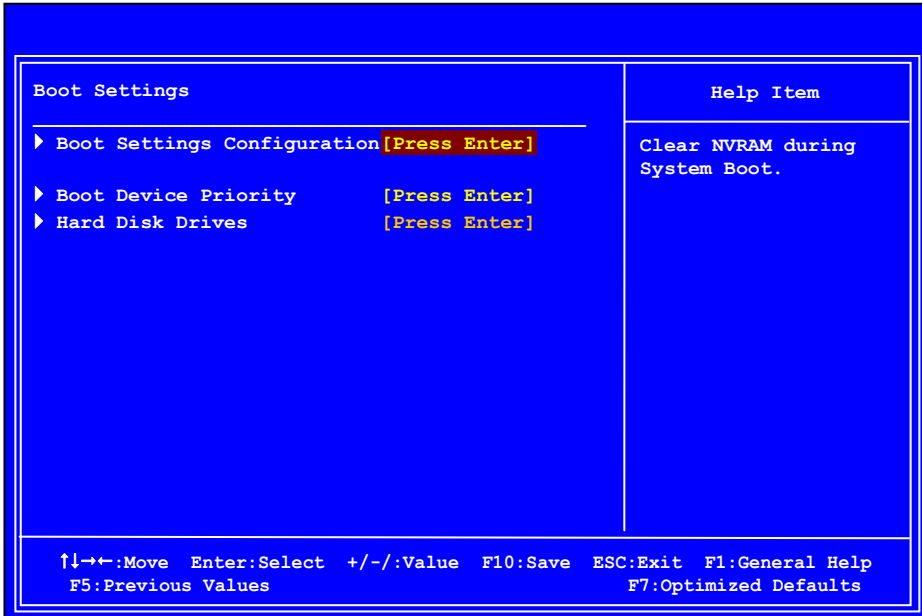

Boot Settings Configuration

This option menu will allow specification of the boot settings such as: Boot screen Logo, Quick boot and Boot up Num-Lock.

Boot Device Priority

This option menu will allow specification of the boot device priority sequence.

Hard Disk Drives

This option menu allows you specification of the Hard Disk boot priority sequence.

Power Management Features

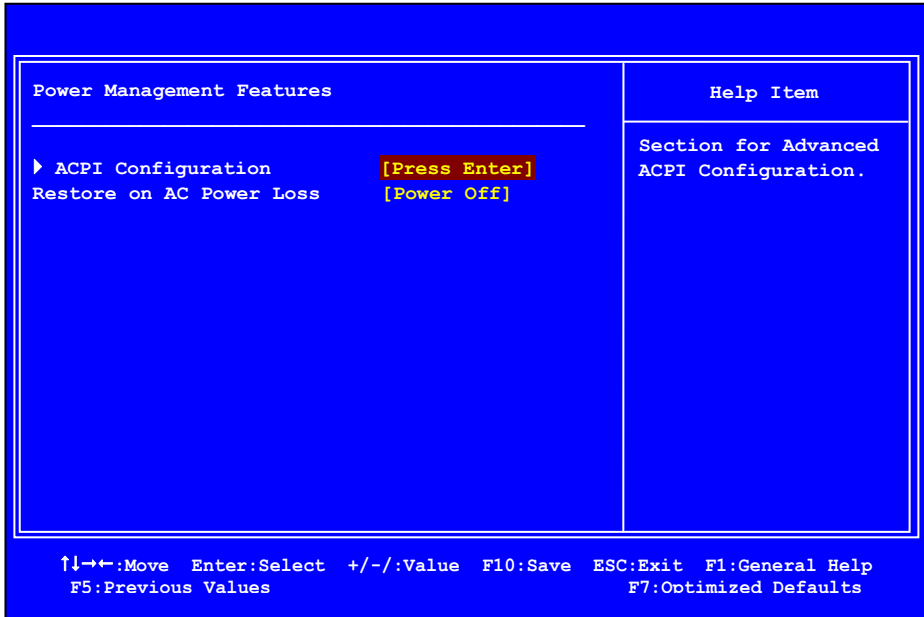

ACPI Configuration

This menu will allow adjustment of ACPI configurations.

Restore on AC Power Loss

This menu allows adjustment of the AC Power Loss parameters.

Hardware Health Configuration

Hardware Health Configure		Help Item
H/W Health Function	[Enabled]	Enables Hardware Health Monitoring Device.
<hr/>		
CPU0 Temperature	:34C/93F	
CPU0 PWM Temperature	:42C/107F	
System0 Temperature	:34C/93F	
CPU1 Temperature	:34C/93F	
CPU1 PWM Temperature	:36C/96F	
System1 Temperature	:34C/93F	
JCPU0 Fan Speed	:3264 RPM	
JPWR0 Fan Speed	:1337 RPM	
JSYS0 Fan Speed	:3864 RPM	
JCPU1 Fan Speed	:3282 RPM	
JPWR1 Fan Speed	:1337 RPM	
JSYS1 Fan Speed	:3922 RPM	

↑|←:Move Enter:Select +/-:Value F10:Save ESC:Exit F1:General Help
F5:Previous Values F7:Optimized Defaults

H/W Health Function

This will enable or disable Hardware Health Monitoring.

CPU Fan Mode Setting

This function allows change of the fan mode configuration.

Frequency/Voltage Control Menu

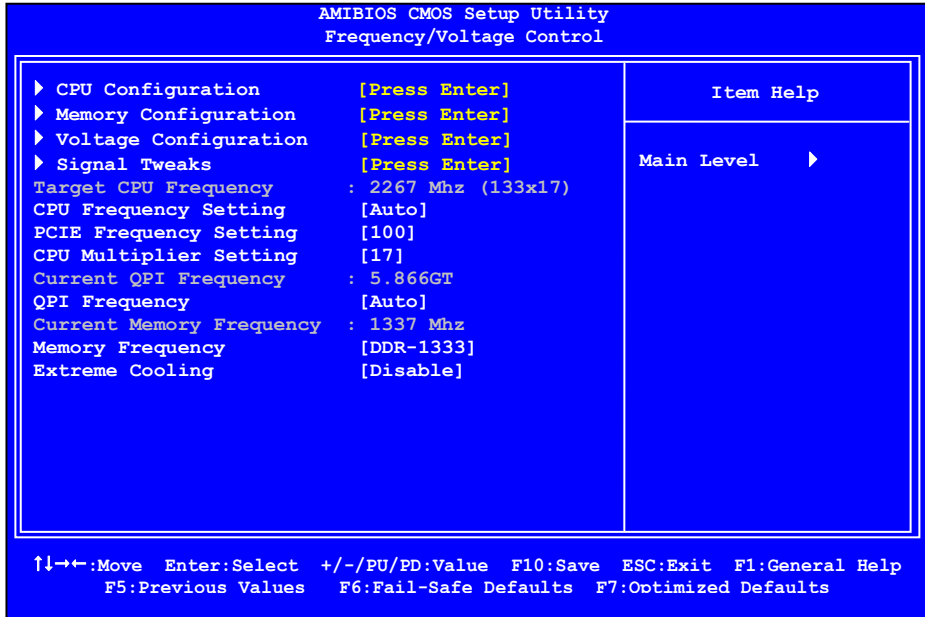

CPU Configuration

This menu will allow the configuration of advanced CPU settings, such as Virtualization Technology, CPU SpeedStep, or CPU power saving options.

Memory Configuration

This menu will allow the configuration of advanced memory settings, including memory frequency and memory timings.

Voltage Configuration

This menu will allow the configuration of all modifiable voltage settings for the system.

Signal Tweaks**

This menu will allow the fine tuning of specific settings and voltage references and signals. ** Intended for Advanced Users **

CPU Frequency Setting

This option allows direct adjustment to the base frequency or Bclk at which the processor will operate at.

PCI-E Frequency Setting

This setting allows for adjustment of the PCI-E operating frequency.

CPU Multiplier Setting

This setting allows adjustment to the processors' clock multiplier(s).

QPI Frequency

This setting allows direct adjustment to the QPI frequency.

Memory Frequency

This setting allows adjustment to the memory or ram operating frequency.

Extreme Cooling

This setting adjusts the systems ability to operate at lower temperatures during extreme overclocking.

Installing Drivers and Software

It is important to remember that *before* installing the driver CD that is shipped in the kit, you need to load your operating system. The motherboard supports Windows XP/Vista and Win7 32 & 64 Bit

The kit comes with a CD that contains utilities, drivers.

The CD that has been shipped with your EVGA Classified SR-2 motherboard contains the following software and drivers:

- Chipset Drivers
- Audio Drivers
- RAID Drivers
- LAN Drivers
- Matrix Storage
- JMicron SATA Drivers
- EVGA E-LEET
- Marvell SATA 6Gbps Drivers
- NEC USB 3.0 Drivers
- Adobe Acrobat Reader
- User Manual

Windows XP/Vista/Win7 Drivers Install

1. Insert the EVGA Classified SR-2 installation CD for the motherboard included in the kit.
2. The CD will autorun. Install the drivers and utilities listed on the install screen.

If the CD does not run, go to My Computer and click on the CD to open.

Table 5. AMI POST Code

Code	Description
03	Initialize BIOS.
04	Check Battery Power and CMOS
05	Initialize interrupt controlling hardware/vector table
06	Initialize system timer
07	Fixes CPU POST interface calling pointer
08	Primary initialization of CPU
C0	Secondary initialization of CPU
C1	Set up boot strap processor information
C2	Set up boot strap processor for POST
C5	Enumerate and set up application processors
C6	Re-enable cache for boot strap processor
C7	Early CPU initialization exit
0A	Initialize keyboard controller
0B	Detect Mouse
0C	Detect Keyboard
0E	Test input devices
13	Early POST initialization of chipset registers
20	Relocate System Management interrupt vector
24	Uncompress and initialize BIOS module
2A	Initialize devices primary
2C	Initialize devices secondary
2E	Initialize output devices
31	Allocate memory for ADM module
33	Initialize silent boot module
37	Display sign-on message
38	Initialize USB controller
39	Initialize DMAC-1 & DMAC-2
3A	Initialize real time clock
3B	Test system memory

Code	Description
3C	Initialization of chipset registers
40	Detect coprocessor
52	Update CMOS memory size
60	Initialize NUM-LOCK
75	Initialize Int-13
78	Initialize IPL devices
7C	Generate and write contents of ESCD
84	Log errors encountered
85	Display errors, if no display check monitor/graphics card
87	Execute BIOS setup if needed or requested
8C	Late POST initialization of chipset registers
8D	Build ACPI tables
8E	Program peripheral parameters
90	Initialize system management interrupt
A1	Prepare for system boot
A2	Initialize IRQ routing table
A4	Display boot option popup
A7	Display system configuration screen
A9	Wait for user input at configuration display
AA	Uninstall POST vector
AB	Prepare BBS for Int 19 boot
AC	End of POST initialization
B1	Save system context for ACPI
00	Pass control to OS
(can vary)	Show CPU Temp (if enabled)

EVGA Glossary of Terms

ACPI - Advanced Configuration and Power Interface

AFR – Alternate Frame Rendering

APIC - Advanced Programmable Interrupt Controller

BIOS - Basic Input Output System

CD-ROM - Compact Disc Read-Only Memory

CMOS - Complementary Metal-Oxide Semiconductor

CPU – Central Processing Unit

D-ICE – Dry Ice Cooling

DDR2 - Double Data Rate 2

DDR3 - Double Data Rate 3

DIMM - Dual In-line Memory Module

DRAM - Dynamic random access memory

DVD - Digital Versatile Disc

DVI – Digital Video Interface

FDC - Floppy Disk Controller

FSB – Front Side Bus

FTW – For The Win!

GHz – Gigahertz

GPU – Graphics Processing Unit

HDD - Hard Disk Drive

HDMI - High-Definition Multimedia Interface
HDR – High Dynamic Range Lighting
HPET - High Precision Event Timer
HT – Hyper-Threading
HSF - Heat Sink Fan
I/O - Input/Output
IDE - Integrated Drive Electronics
IEEE - Institute of Electrical and Electronics Engineers
IGP - Integrated Graphics Processors
IRQ - Interrupt Request
JBOD - Just a Bunch of Disks
JEDEC - Joint Electron Device Engineering Council
LAN - Local Area Network
LCD - Liquid Crystal Display
LGA – Land Grid Array
LN2 – Liquid Nitrogen Cooling
MAC - Media Access Control
MCP - Media and Communications Processor
MHz – Megahertz
NB – Northbridge
NCQ - Native Command Queuing
NIC - Network Interface Card
NTFS - New Technology File System
OEM - Original Equipment Manufacturer
PATA - Parallel Advanced Technology Attachment
PCB - Printed Circuit Board
PCI - Peripheral Component Interconnect

PCI-E - Peripheral Component Interconnect Express

PCI-x - Peripheral Component Interconnect Extended

POST – Power on Self Test

PWM – Pulse Width Modulation

QDR - Quad Data Rate

QPI – Quick Path Interconnect

RAID - Redundant Array of Inexpensive Disks

RGB - Red Green Blue

SATA - Serial Advanced Technology Attachment

SB - Southbridge

SCSI - Small Computer System Interface

SFR – Split Frame Rendering

SLI - Scalable Link Interface

SPD - Serial Presence Detect

SPDIF - Sony/Philips Digital Interconnect Format

SPP - System Platform Processors

TCP/IP - Transmission Control Protocol/Internet Protocol

USB - Universal Serial Bus

VDroop - V-core Voltage Drop

VGA - Video Graphics Array