

User Guide

EVGA nForce 790i SLI FTW
Motherboard

Table of Contents

User Guide	i
EVGA nForce 790i SLI FTW Motherboard	i
Before You Begin.....	viii
Parts NOT in the Kit	viii
Intentions of the Kit	viii
EVGA nForce 790i SLI FTW Motherboard	1
Motherboard Specifications.....	1
Unpacking and Parts Descriptions	3
Unpacking	3
Equipment.....	3
EVGA nForce 790i SLI FTW Motherboard	4
Hardware Installation	7
Safety Instructions	7
Preparing the Motherboard.....	8
Installing the CPU.....	8
Installing the CPU Fan.....	9
Installing Memory DIMMs	9
Installing the Motherboard	10
Installing the I/O Shield	10
Securing the Motherboard into the Chassis	11
Connecting Cables and Setting Switches	11
Power Connections.....	12
24-pin ATX Power (PWR1)	13
8-pin ATX 12V Power (PWR2)	14
Connecting IDE Hard Disk Drives	14

Connecting Serial ATA Cables	15
Connecting Internal Headers	16
Front Panel Header	16
IEEE 1394a	17
USB Headers.....	18
Audio	19
HD Audio	20
SPDIF Audio	21
Fan Connections	22
COM1	23
FDD Connector	24
Expansion Slots.....	24
PCI Slots.....	25
PCI Express x1 Slots.....	25
PCI Express x16 Slots.....	25
Onboard Buttons.....	26
Clear CMOS Button	26
RESET and POWER Button	26
Post Debug LED and LED Status Indicators	27
Post Debug LED.....	27
LED Status Indicators	27
Configuring the BIOS	28
Enter BIOS Setup.....	29
Main Menu.....	29
Standard CMOS Features Menu.....	32
Date and Time	33
IDE Channel and SATA Channel.....	33
Drive A.....	34
Halt On	35

Memory	36
Advanced BIOS Features.....	37
Hard Disk Boot Priority.....	38
CD-ROM Device Priority	38
Network Boot Priority	38
CPU Internal Cache.....	38
Quick Power On Self Test.....	39
First/Second/Third Boot Device.....	39
Boot Other Device.....	39
Boot Up NumLock Status.....	39
Security Option.....	40
APIC Mode.....	40
MPS Version Control For OS	40
Full Screen LOGO Show	40
Advanced Chipset Features.....	41
System BIOS Cacheable.....	41
HPET Function	41
Integrated Peripherals Menu.....	42
IDE Function Setup	43
RAID Config.....	44
USB Config.....	44
MAC Config.....	45
IEEE1394 controller.....	45
HD Audio	45
Onboard FDC Controller	45
Onboard Serial Port 1.....	45
Power Management Setup Menu	46
ACPI Function	46
ACPI Suspend Type.....	46

Soft-Off by PBNT	47
WOL(PME#) From Soft-Off.....	47
WOR(RI#) From Soft-Off	47
PWRON After PWR-Fail	47
Power On by Alarm	47
POWER ON Function	48
PnP/PCI Configuration Menu.....	49
Init Display First.....	49
Resources Controlled By	50
IRQ Resources	50
PCI/VGA Palette Snoop	50
PCI Latency Timer (CLK).....	51
Maximum Payload Size.....	51
PC Health Status Menu.....	52
Dynamic Fan Control.....	53
Frequency/Voltage Control Menu	54
System Clocks	55
Frequency Settings	56
HT Multiplier	56
Spread Spectrum Setting.....	57
FSB & Memory Config.....	58
CPU Feature.....	62
System Voltages.....	64
Load Timing/Voltage Set.....	66
Save Timing/Voltage Set.....	66
Installing Drivers and Software	67
Windows XP Drivers Install	67
Appendix A. POST Codes.....	70

List of Figures

Figure 1.	EVGA nForce 790i SLI FTW Motherboard Layout	5
Figure 2.	Chassis Backpanel Connectors	6
Figure 3.	Power Supply Connectors	12
Figure 4.	PWR1 Motherboard Connector.....	13
Figure 5.	BIOS CMOS Setup Utility Main Menu.....	30
Figure 6.	Standard CMOS Features Menu.....	32
Figure 7.	Advanced BIOS Features Menu.....	37
Figure 8.	Advanced Chipset Features.....	41
Figure 9.	Integrated Peripherals Menu	42
Figure 10.	Power Management Setup Menu.....	46
Figure 11.	PnP/PCI Configuration Menu	49
Figure 12.	PC Health Status Menu.....	52
Figure 13.	Frequency/Voltage Control Menu	54
Figure 14.	System Clocks Menu	55
Figure 15.	FSB & Memory Config Menu.....	58
Figure 16.	CPU Feature Menu.....	62
Figure 17.	System Voltages Menu.....	64

Before You Begin...

Parts NOT in the Kit

This kit contains all the hardware necessary to install and connect your new EVGA nForce® 790i SLI FTW motherboard. However, it does not contain the following items that must be purchased separately to make the motherboard functional.

- ❑ **Intel Microprocessor**
- ❑ **System Memory**
- ❑ **Cooling fan for the Microprocessor**
- ❑ **Graphics Card**
- ❑ **Power Supply**

EVGA assumes you have purchased all necessary parts needed to allow for proper system functionality.

Intentions of the Kit

This kit provides you with the motherboard and all connecting cables necessary to install the motherboard into a PC case. If you are *building* a PC, you will use most of the cables provided in the kit. If however, you are *replacing* a motherboard, you will not need many of the cables.

When *replacing* a motherboard in a PC case, it is highly recommended to reinstall the operating system even though the current hard disk drives may already have one installed.

EVGA nForce 790i SLI FTW Motherboard

Thank you for purchasing the EVGA nForce 790i SLI FTW Motherboard. This motherboard offers the tools, performance, and overclocking potential that PC Enthusiasts demand. When combined with two or three SLI-Ready NVIDIA GeForce graphics cards, you get innovative NVIDIA SLI Technology for enhanced visual performance.

Motherboard Specifications

- ❑ Size
ATX form factor of 12 inches x 9.6 inches
- ❑ Microprocessor support
Intel Core 2 Extreme, Intel Core 2 Quad, Intel Core 2 Duo, Pentium EE, Pentium D, Pentium
- ❑ Operating systems:
Supports Windows XP 32bit/64bit and Windows Vista 32bit/64bit
- ❑ Contains NVIDIA nForce 790i SLI MCP and SPP
- ❑ System Memory support
Supports dual channel JEDEC DDR3-1600MHz and SLI-Ready memory up to 2000 MHz. Supports up to 8 GBs of DDR3 memory.
- ❑ Ten USB 2.0 Ports
 - Supports hot plug
 - Ten USB 2.0 ports (six rear panel ports, two 10-pin onboard USB headers)
 - Supports wake-up from S1 and S3 mode
 - Supports USB 2.0 protocol up to 480 Mbps transmission rate

- ❑ Onboard Serial ATA II
 - 300MBps data transfer rate
 - Six Serial ATA II connectors from south bridge with support for RAID 0, RAID 1, RAID 0+1, RAID 5, and JBOD
 - Four Serial ATA II connectors from JMicron's JMB362 (one rear panel port for eSATA, three onboard)
 - Supports hot plug and NCQ (Native Command Queuing)
- ❑ Onboard LAN
 - Dual LAN interface built-in onboard
 - Supports 10/100/1000 Mbit/sec Ethernet
- ❑ Onboard 1394
 - Supports hot plug
 - Two 1394a ports (one rear panel port, one onboard header) with rate of transmission at 400 Mbps
- ❑ Onboard Audio
 - Azalia High-Definition audio
 - Supports 8-channel audio
 - Supports S/PDIF output
 - Supports Jack-Sensing function
- ❑ Triple PCI Express x16 Support
 - 2 x16 PCI Express 2.0
 - 1 x16 PCI Express 1.0
 - Supports 4 GB/sec (8 GB/sec concurrent) bandwidth
 - Low power consumption and power management features
- ❑ Green Function
 - Supports ACPI (Advanced Configuration and Power Interface)
 - Supports S0 (normal), S1 (power on suspend), S3 (suspend to RAM), S4 (Suspend to disk - depends on OS), and S5 (soft - off)
- ❑ Expansion Slots
 - Two PCI slots
 - Two PCI Express x1 slot
 - Three PCI Express x16 Graphics slots

Unpacking and Parts Descriptions

Unpacking

The EVGA nForce 790i SLI FTW motherboard comes with all the necessary cables for adding a motherboard to a new chassis. If you are replacing a motherboard, you may not need many of these cables.

Be sure to inspect each piece of equipment shipped in the packing box. If anything is missing or damaged, contact your reseller.

All parts shipped in this kit are RoHS-compliant (lead-free) parts.

Equipment

The following equipment is included in the EVGA nForce 790i SLI FTW motherboard box.



EVGA nForce 790i SLI FTW Motherboard

This PCI Express motherboard contains the NVIDIA nForce 790i SLI SPP and MCP and is SLI-ready.



1 – Visual guide

Helps to visually guide you through the hardware installation of the motherboard.



1 - I/O Shield

Installs in the chassis to block radio frequency transmissions, protect internal components from dust and foreign objects and aids in proper airflow within the chassis.



1 - Floppy Cable

Used to attach a floppy drive to the motherboard.



3 - 2-Port SATA Power Cables

Allows a Molex power connector to adapt to a SATA power connector.



1 - IEEE 1394a (Firewire) Cable

Provides one additional IEEE1394 ports the back panel of the chassis.



1 - USB 2.0 4-Port Cable

Provides four additional USB ports to the back panel of the chassis.



6 - SATA Signal Cables

Used to support the Serial ATA protocol and each one connects a single drive to the motherboard



1 - Serial Port (Comm2) Cable

Used for serial based legacy devices



1 - IDE-ATA 133 HDD Cable

Passes data between the IDE connection on the motherboard and IDE device.



1 - 2-Way SLI Bridge

Allows for a 2-Way SLI set up with compatible NVIDIA GeForce Graphics Cards



1 - 3-Way SLI Bridge

Allows for a 3-Way SLI set up with compatible NVIDIA GeForce Graphics Cards

EVGA nForce 790i SLI FTW Motherboard

The EVGA nForce 790i SLI FTW motherboard with the NVIDIA nForce 790i SLI SPP and MCP processors is a PCI Express, SLI-ready motherboard. Figure 1 shows the motherboard and Figures 2 shows the back panel connectors.

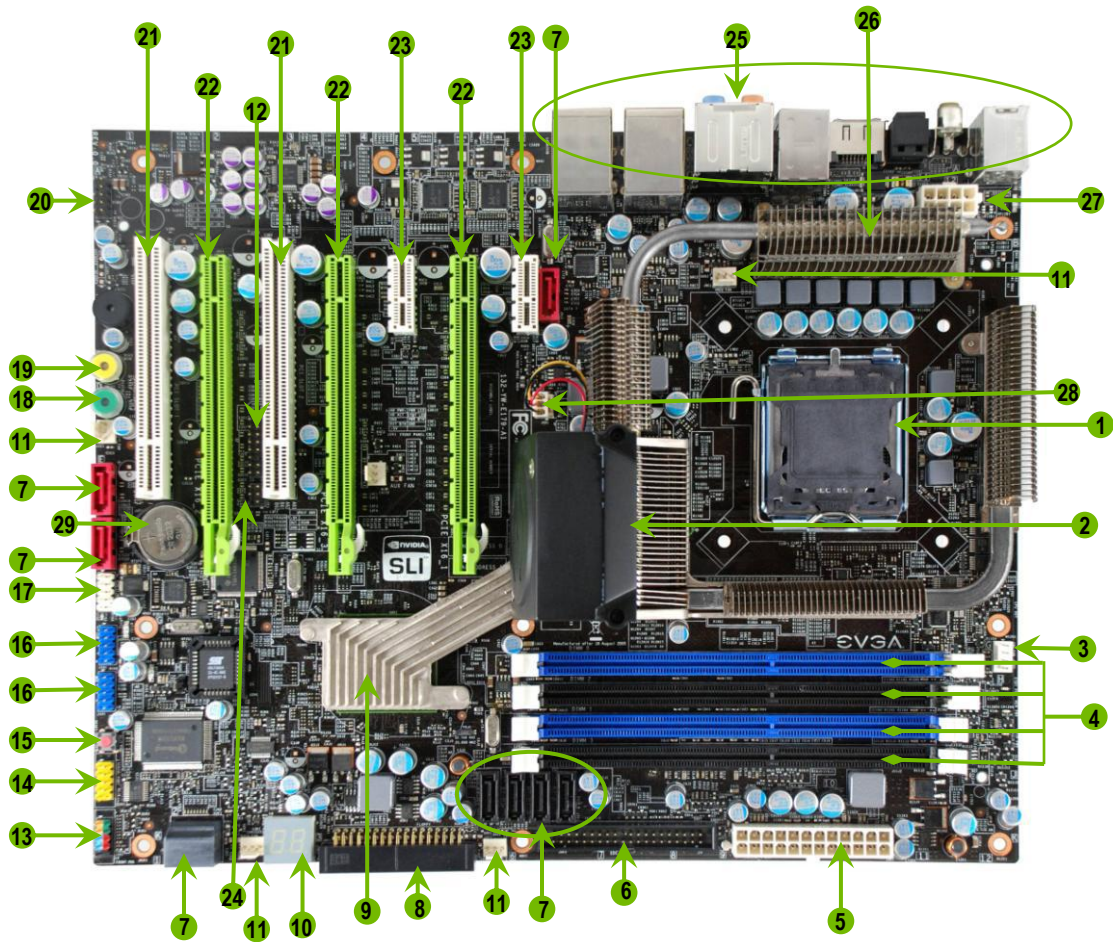

1. CPU Socket – For Intel LGA 775 CPUs	11. Fan connectors – Connect auxiliary fans to these headers	21. PCI slots – For PCI based components
2. nForce 790i SLI SPP with Active Cooling – Also known as the Northbridge	12. HD Audio Connector – For Hi-Definition Audio	22. PCI Express x16 slots (SLI) – For graphics cards, multiple slots are used for SLI configurations
3. CPU fan connector – Connect CPU Fan to this connector	13. Front panel connector – For use with a system chassis	23. PCI Express x1 slot – Exclusive for devices that require a PCI-E x1 slot
4. DDR3 DIMM slots 0 – 3 – For System Memory	14. Serial connector – For Serial Port Cable	24. SPDIF connector – Digital Audio connection
5. 24-pin ATX power connector – Main Power Connection	15. CMOS Clear Button – Easily clears the system BIOS	25. Backpanel connectors (Figure 2)
6. IDE connector – For IDE devices such as a CD-ROM or Hard Disk Drive	16. USB headers – For USB Port Cable	26. Heat dissipater – Passive heatsink for Voltage Regulators
7. Serial-ATA (SATA) connectors – For SATA devices such as a CD-ROM or Hard Disk Drive	17. 1394a connector – For Firewire Port Cable	27. 8-pin ATX_12V power connector – CPU 8-Pin Power connector
8. FDD connector – Floppy Disk Drive Connector	18. Power button – With integrated power LED indicator	28. MCP/SPP fan connector – Connect Northbridge fan to this connector
9. NVIDIA MCP (passive heat sink) – Also known as the Southbridge	19. Reset button – With integrated HDD activity LED	29. Motherboard CMOS Battery – Helps retain system BIOS settings
10. LED POST Code Readout – See Appendix A. for Code Descriptions	20. Front panel Audio connector – For use with a system chassis	

Figure 1. EVGA nForce 790i SLI FTW Motherboard Layout

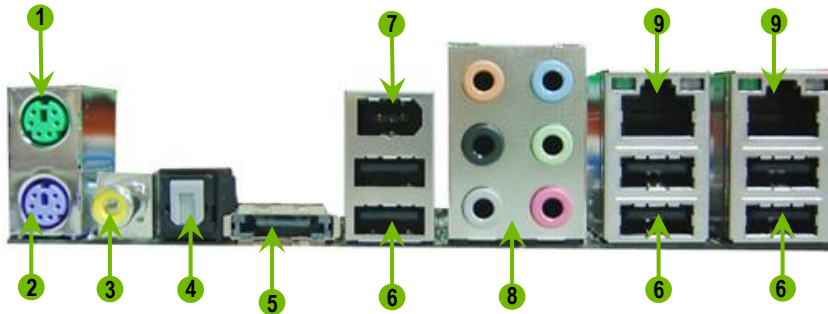

1. PS/2 Mouse Port
2. PS/2 Keyboard Port
3. Coaxial SPDIF output
4. Optical SPDIF output
5. eSATA port
6. USB 2.0 ports (Six)
7. 1394a (Firewire) Port
8. Audio Port
9. LAN Port with LEDs to indicate status.

Audio Port	2-Channel	6-Channel	8-Channel
Blue	Line-In	Line-In	Line-In
Green	Line-Out	Front Speaker Out	Front Speaker Out
Pink	Mic In	Mic In	Mic In
Orange		Center/Subwoofer	Center/Subwoofer
Black		Rear Speaker Out	Rear Speaker Out
Grey			Side Speaker Out

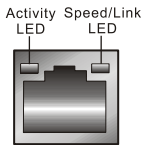

Activity LED Status	Description
Off	No data transmission
Blinking (Green)	Data transmission

Speed/Link LED Status	Description
Yellow	1000 Mbps data rate
Green	100 Mbps data rate
Off	10 Mbps data rate

Figure 2. Chassis Backpanel Connectors

Hardware Installation

This section will guide you through the installation of the motherboard. The topics covered in this section are:

- ❑ Preparing the motherboard
 - Installing the CPU
 - Installing the CPU fan
 - Installing the memory
- ❑ Installing the motherboard
- ❑ Connecting cables and setting switches

Safety Instructions

To reduce the risk of fire, electric shock, and injury always follow basic safety precautions.

Remember to remove power from your computer by disconnecting the AC main source before removing or installing any equipment from/to the computer chassis.

Preparing the Motherboard

Installing the CPU

Be very careful when handling the CPU. Make sure not to bend or break any pins in the CPU socket. Hold the processor only by the edges and do not touch the bottom of the processor.

Use the following procedure to install the CPU onto the motherboard.

1. Unhook the socket lever by pushing *down* and *away* from the socket.
2. Lift the load plate. There is a protective socket cover on the load plate to protect the socket when there is no CPU installed.
3. Remove the protective socket cover from the load plate.
4. Remove the processor from its protective cover, making sure you hold it only by the edges. It is a good idea to save the cover so that whenever you remove the CPU, you have a safe place to store it.
5. Align the notches in the processor with the notches on the socket.
6. Lower the processor straight down into the socket with out tilting or sliding it into the socket



Align notches with notches on the CPU

Make sure the CPU is fully seated and level in the socket.

7. Close the load plate over the CPU and press down while you close and engage the socket lever.



Installing the CPU Fan

There are many different fan types that can be used with this motherboard. Follow the instruction that came with you fan assembly. Be sure that the fan orientation is correct for your chassis type and your fan assembly.

Installing System Memory (DIMMs)

Your new motherboard has four 240-pin slots for DDR3 memory. These slots support 256 MB, 512 MB, 1 GB, and 2 GB DDR3. There must be at least one memory bank populated to ensure normal operation. Use the following recommendations for installing memory. (See Figure 1 on page 5 for the location of the memory slots.)

For memory over 1600MHz(PC3 12800) use slots 2 and 3 (black).

- ❑ **One DIMM:** Install into slot 3. You can install the DIMM into any slot; however, slot 3 is preferred.
- ❑ **Two DIMMS:** Install into either slots: 0 and 1 or 2 and 3. The idea is to not have the DIMMS in adjacent slots.
- ❑ **Four DIMMS:** Install into slots 0, 1, 2, and 3.

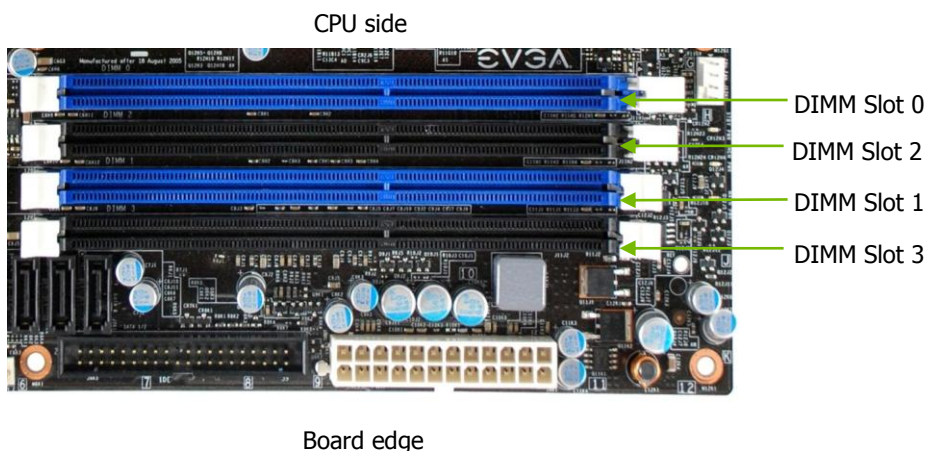

Use the following procedure to install memory DIMMS. Note that there is only one gap near the center of the DIMM slot. This slot matches the slot on the memory DIMM to ensure the component is installed properly.

1. Unlock a DIMM slot by pressing the module clips outward.
2. Align the memory module to the DIMM slot and insert the module vertically while applying light downward pressure to properly seat the DIMM. The plastic clips at both sides of the DIMM slot automatically lock the DIMM into the connector.

Installing the Motherboard

The sequence of installing the motherboard into the chassis depends on the chassis you are using and if you are replacing an existing motherboard or working with an empty chassis. Determine if it would be easier to make all the connections prior to this step or to secure the motherboard and then make all the connections. It is normally easier to secure the motherboard first.

Use the following procedure to install the I/O shield and secure the motherboard into the chassis.

Be sure that the CPU fan assembly has enough clearance for the chassis covers to lock into place and for the expansion cards. Also make sure the CPU Fan assembly is aligned with the vents on the covers.

Installing the I/O Shield

The motherboard kit comes with an I/O shield that is used to block radio frequency transmissions, protects internal components from dust and foreign objects, and promotes correct airflow within the chassis.

Before installing the motherboard, install the I/O shield from the *inside* of the chassis. Press the I/O shield into place and make sure it fits securely. If the I/O shield does not fit into the chassis, you would need to obtain the proper size from the chassis supplier.

Securing the Motherboard into the Chassis

Most computer chassis have a base with mounting studs or spacers to allow the mother board to be secured to the chassis and help to prevent short circuits. If there are stud(s) that do not align with a mounting hole on the motherboard, it is recommended that you remove that stud(s) to prevent the possibility of a short circuit. In most cases, it is recommended to secure the motherboard using a minimum of eight (8) to ten (10) studs.

1. Carefully place the motherboard onto the studs/spacers located inside the chassis.
2. Align the mounting holes with the studs/spacers.
3. Align the connectors to the I/O shield.
4. Ensure that the fan assembly is aligned with the chassis vents according to the fan assembly instruction.
5. Secure the motherboard with a minimum of eight-to-ten screws.

Connecting Cables

This section takes you through all the connections necessary on the motherboard. This will include:

- ❑ Power Connections
 - 24-pin ATX power (**PWR1**)
 - 8-pin ATX 12V power (**PWR2**)
- ❑ Internal Headers
 - Front panel
 - IEEE 1394a
 - USB Headers
 - Audio
 - COM
- ❑ FDD
- ❑ IDE

- ❑ Serial ATA II
- ❑ Chassis Fans
- ❑ Rear panel USB 2.0 Adapter
- ❑ Expansion slots
- ❑ CMOS Clear Button

See Figure 1 on page 5 to locate the connectors and button referenced in the following procedure.

Power Connections

To support 3-way SLI, this motherboard has the following specific power supply requirements:

- ❑ Minimum 1000 W peak power
- ❑ Six PCI-E power connectors configured in either of the following configurations (see Figure 3):
 - Three 6-pin (3x2) and three 8-pin (4x2) PCI-E power connectors or
 - Six 6-pin (3x2) PCI-E power connectors



8-pin (4x2) PCI-E Connector



6-pin (3x2) PCI-E connector

Figure 3. Power Supply Connectors

Make sure you have enough power to cover all the expansion cards you will be installing. To determine what your power requirements are for your specific configuration or a certified power supply vendor, refer to www.slizone.com.

24-pin ATX Power (PWR1)

PWR1 is the main power supply connector located along the edge of the board next to the DIMM slots. Make sure that the power supply cable and pins are properly aligned with the connector on the motherboard. Firmly plug the power supply cable into the connector and make sure it is secure.



PWR1 connector
Plug power cable from power supply to PWR1

Board edge

Figure 4. PWR1 Motherboard Connector

Table 1. PWR1 Pin Assignments

Connector	Pin	Signal	Pin	Signal
	1	+3.3V	13	+3.3V
	2	+3.3V	14	-12V
	3	GND	15	GND
	4	+5V	16	PS_ON
	5	GND	17	GND
	6	+5V	18	GND
	7	GND	19	GND
	8	PWROK	20	RSVD
	9	+5V_AUX	21	+5V
	10	+12V	22	+5V
	11	+12V	23	+5V
	12	+3.3V	24	GND

8-pin ATX 12V Power (PWR2)

PWR2, the 8-pin ATX 12V power connection, is used to provide power to the CPU. Align the pins to the connector and press firmly until seated.

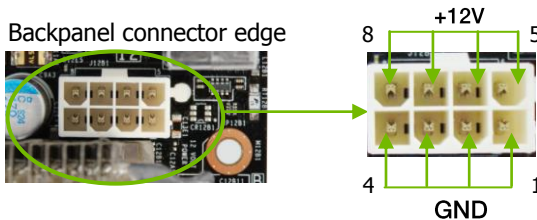

Connecting IDE Hard Disk Drives

The IDE connector supports Ultra ATA 133/100/66 IDE hard disk drives.

1. Connect the blue connector (the cable end with a single connector) to the motherboard.
2. Connect the black connector (the cable with two closely spaced black and grey connectors) to the Ultra ATA master device.
3. Connect the gray connector to a slave device.

If you install two hard disk drives, you must configure the second drive as a slave device by setting its jumper accordingly. Refer to the hard disk documentation for the jumper settings.

If an ATA-66/100 disk drive and a disk drive using any other IDE transfer protocol are attached to the same cable, the maximum transfer rate between the drives may be reduced to that of the slowest drive.

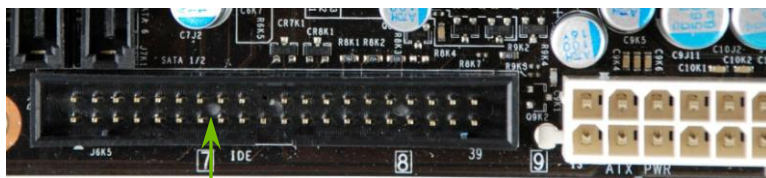

IDE Connector

Board Edge

Connecting Serial ATA Cables

The Serial ATA connector is used to connect a Serial ATA I or Serial ATA II device to the motherboard. These connectors support the thin Serial ATA cables for primary storage devices. The current Serial ATA II interface allows up to 300MB/s data transfer rate.

There are ten Serial ATA connectors on the motherboard, The six black connectors (SATA1~SATA6) from south bridge chipset that support RAID 0, RAID 1, RAID 5, RAID 0+1 and JBOD configurations and four connectors (SATA7~SATA10) from JMicron's JMB362.

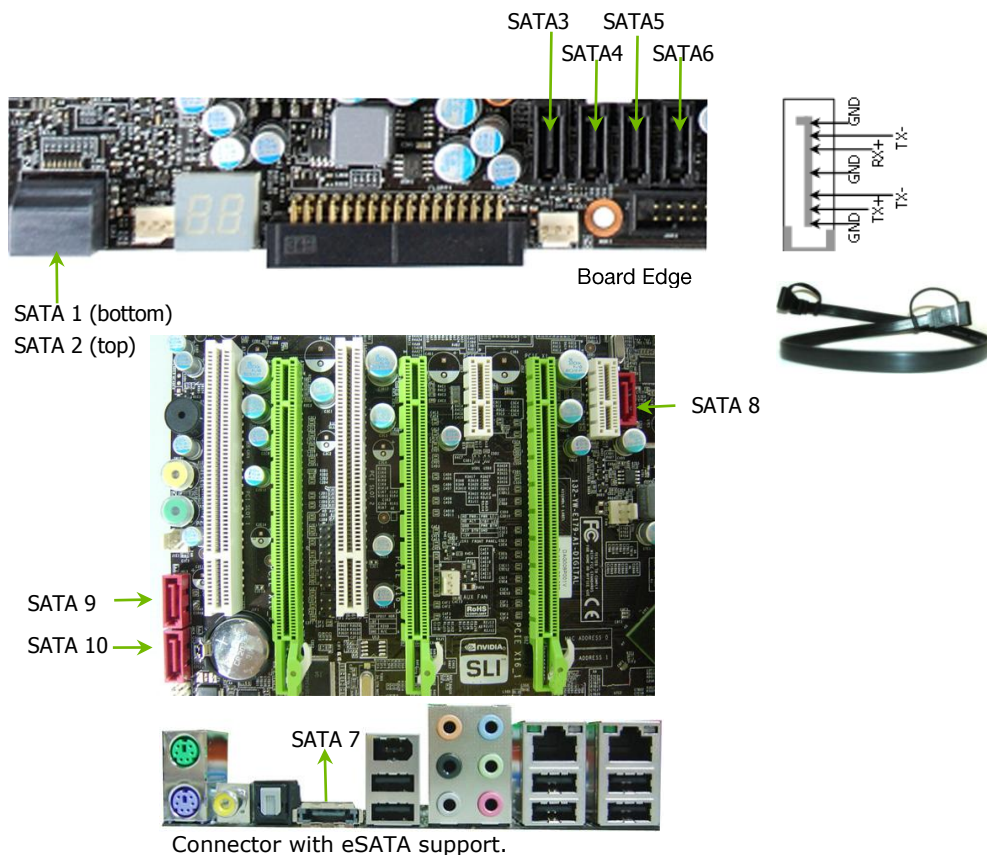

Connecting Internal Headers

Front Panel Header

The front panel header on this motherboard is used to connect the following four cables.

(see Table 2 for pin definitions):

❑ PWRLED

Attach the front panel power LED cable to these two pins of the header. The Power LED indicates the system's status. When the system is turned on, the LED is on. When the system is turned off, the LED is off. When the system is in S1, S1, S3, S4 standby, the LED will blink.

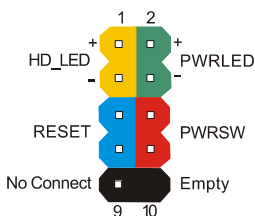

Some chassis do not have all four cables. Be sure to match the name on the connectors to the corresponding pins.

❑ PWR SW

Attach the power button cable from the case to these two pins. Pressing the power button on the front panel turns the system on and off rather than using the onboard power button.

❑ HD_LED

Attach the hard disk drive indicator LED cable to these two pins. The HDD indicator LED indicates the activity status of the hard disks.

❑ RESET

Attach the reset button cable from the front panel of the case to these two pins. The system restarts when the reset button is pressed.

Table 2. Front Panel Header Pins

	Pin	Signal
HD_LED	1	HD_PWR
	3	HD Active
PWRLED	2	PWR LED
	4	STBY LED
RESET	5	Ground
	7	RST BTN
PWR SW	6	PWR BTN
	8	Ground
No Connect	9	+5V
Empty	10	Empty

IEEE 1394a

The IEEE 1394a (*Firewire*) expansion cable bracket is provided in the box but if you do not require the additional external connections, you do not need to install it.

1. Secure the bracket to the rear panel of your chassis.
2. Connect the end of the cable to the IEEE 1394a connector on the motherboard.

Table 3. IEEE 1394a Connector Pins

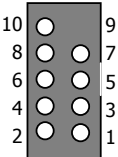
Connector	Pin	Signal
IEEE 1394a Connector 	1	TPA+
	2	TPA-
	3	GND
	4	GND
	5	TPB+
	6	TPB-
	7	+12V
	8	+12V
	9	Empty
	10	GND

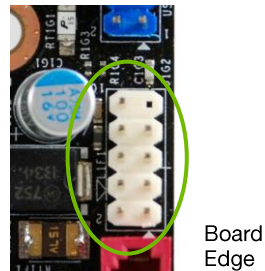

USB Headers

This motherboard contains six (6) USB 2.0 ports that are exposed on the rear panel of the chassis (Figure 2). The motherboard also contains two 10-pin internal header connectors onboard that can be used to connect an optional external bracket containing four (4) USB 2.0 ports.

3. Secure the bracket to the rear panel of your chassis.
4. Connect the two ends of the cables to the USB 2.0 headers on the motherboard.

Table 4. USB 2.0 Header Pins

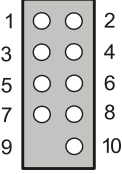
Connector	Pin	Signal
USB 2.0 Header Connector 	1	5V_DUAL
	3	Data-
	5	Data+
	7	GND
	9	Empty
	Pin	Signal
	2	5V_DUAL
	4	Data-
	6	Data+
	8	GND
10	No Connect	

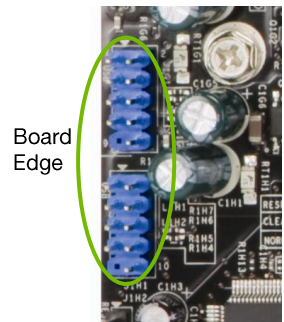

Front Audio

The audio connector uses the AC97 standard and provides two kinds of audio output choices: Front Audio and Rear Audio. The front Audio supports re-tasking function.

Table 5. Front Audio Connector

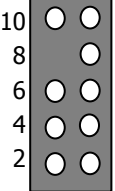
Connector	Pin	Signal
Front Audio Connector 	1	PORT1_L
	2	AUD_GND
	3	PORT1_R
	4	PRECENCE_J
	5	PORT2_R
	6	SENSE1_RETURN
	7	SENSE_SEND
	8	Empty
	9	PORT2_L
	10	SENSE2_RETURN

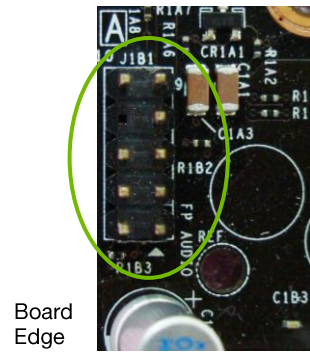

HD Audio

The HD Audio connection supports HD audio standard. Use this if the case does not use the AC97 connectors.

Table 6. HD Audio Connector

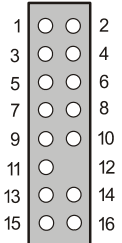
Connector	Pin	Signal
HD audio Connector 	1	BCLK
	2	GND
	3	RESET#
	4	+3.3V
	5	SYNC
	6	GND
	7	SDATA_OUT
	8	+3.3V
	9	SDATA_IN0
	10	+12V
	11	SDATA_IN1
	12	KEY
	13	NC
	14	+3.3V_DUAL
	15	SDATA_IN2
	16	GND

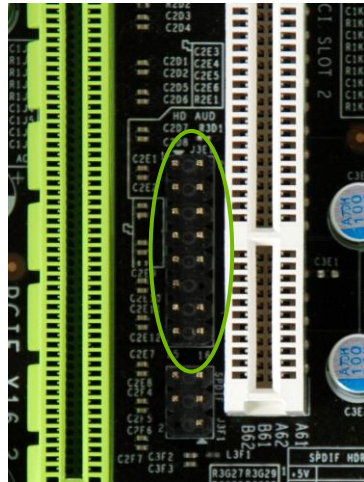

SPDIF Audio

The SPDIF header is used to connect to an NVIDIA graphics card for HDMI audio.

Table 7. SPDIF Audio Connector

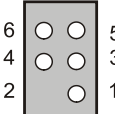
Connector	Pin	Signal
SPDIF Audio Connector 	1	Power
	2	No Pin
	3	SPDIF
	4	SPDIFI
	5	GROUND
	6	GROUND



Fan Connections

There are seven fan connections on this motherboard. The fan speed can be detected and viewed in the **PC Health Status** section of the CMOS Setup. The fans are automatically turned off after the system enters S3, S4 and S5 mode.

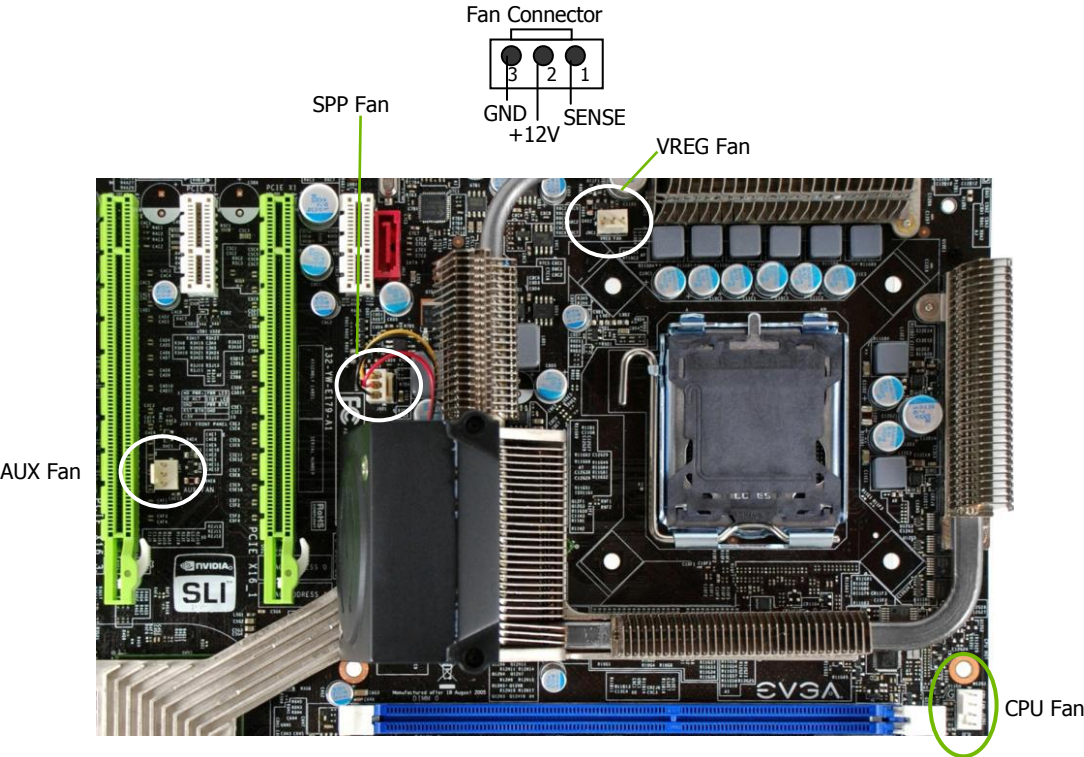

Note that the CPU fan cable can be either a 3-pin or a 4-pin connector. Connect a 3-pin connector to pins 1, 2, and 3 on the motherboard connector.

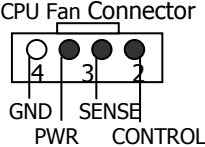

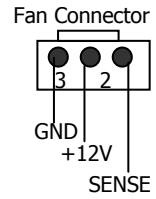
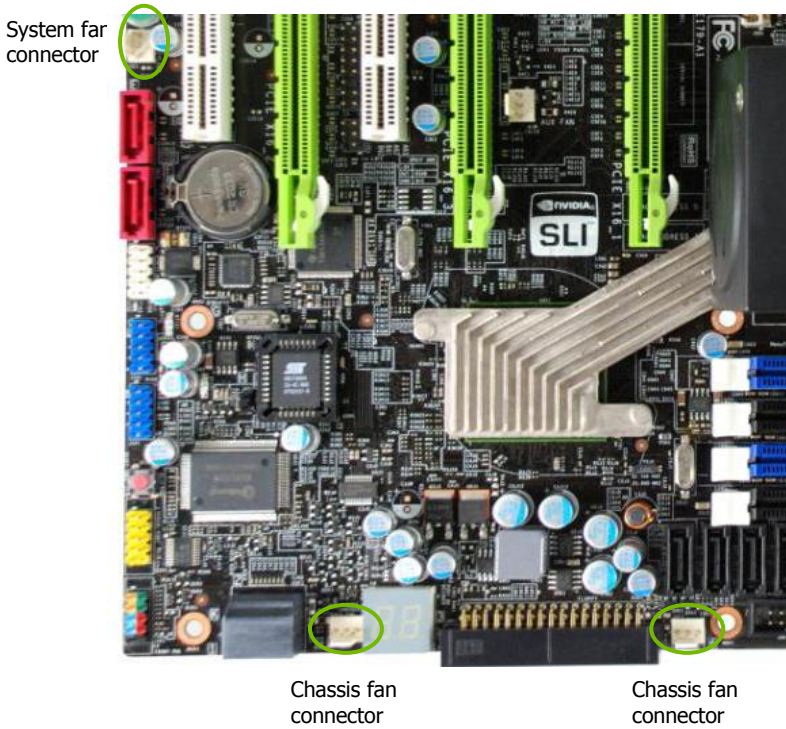

COM1

The motherboard kit provides a serial COM port bracket for your system. Connect one side of the cable to the header and then attach the serial COM device to the other side of the cable.

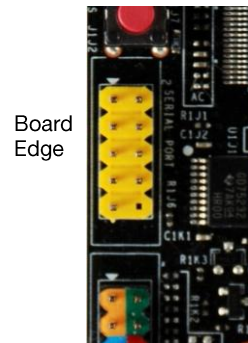

FDD Connector

The motherboard supports a standard 360K, 720K, 1.2M, 1.44m, and a 2.88M floppy disk drive (FDD).



Board Edge

Expansion Slots

The EVGA nForce 790i SLI FTW motherboard contains seven expansion slots, five PCI Express slots and two PCI slots.

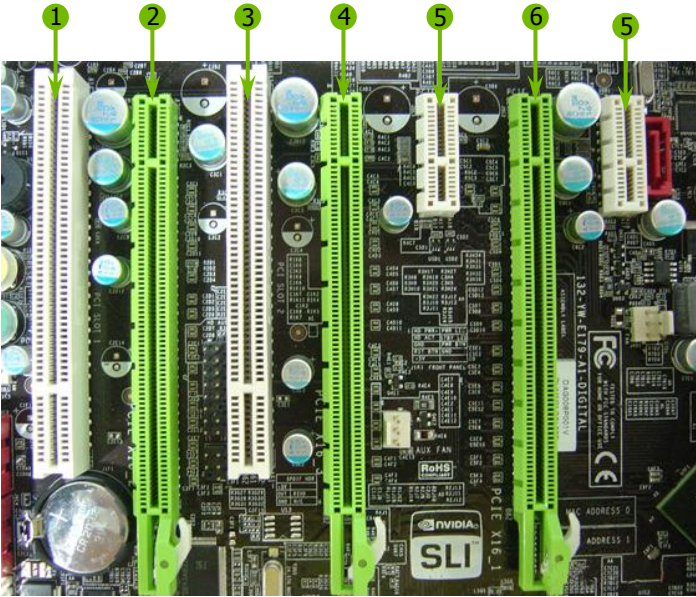

- 1 - PCI slot 1
- 2 - PCIe x16 slot 2
- 3 - PCI slot 2
- 4 - PCIe x16 slot 3
- 5 - PCIe x1 slots
- 6 - PCIe x16 slot 1 (Primary)

PCI Slots

The two PCI slots support many expansion cards such as a LAN card, USB card, SCSI card and other cards that comply with PCI specifications. When installing a card into the PCI slot, be sure that it is fully seated. Secure the card's metal bracket to the chassis back panel with the screw used to hold the blank cover.

PCI Express x1 Slots

There are two PCI Express x1 slots that are designed to accommodate less bandwidth-intensive cards, such as a modem or LAN card. The x1 slots provide 250 MB/sec bandwidth.

PCI Express x16 Slots

These three PCI Express x16 slots are reserved for graphic or video cards. The bandwidth of the x16 slot is up to 4GB/sec (8GB/sec concurrent). The motherboard supports three PCI-Express graphics cards using NVIDIA's SLI technology.

When installing a PCI Express x16 card, be sure the retention clip snaps and locks the card into place. If the card is not seated properly, it could cause a short across the pins. Secure the card's metal bracket to the chassis back panel with the screw used to hold the blank cover.

Onboard Buttons

These onboard buttons include RESET, POWER and Clear CMOS. Easily turn on/off the system, and conveniently clear the CMOS.

Clear CMOS Button

The motherboard uses the CMOS ROM to store all the set parameters in the bios. The CMOS can be cleared by using the following procedure:

1. Turn off the AC power supply.
2. Press and hold the clear CMOS button for 10 seconds.
3. Turn the AC power supply back on.

RESET and POWER Button

These onboard buttons turn the system on/off easily and is especially handy for debugging or testing the system.

The POWER button with LED indicates the system's status. When the system is powered on status, the LED is green. When the system is in Standby mode, the LED is yellow.

The RESET button with LED indicates the activity status of the hard disks. The LED is orange.



Post Debug LED and LED Status Indicators

Post Debug LED

Provides a two-digit POST code to allow for quick and easy debugging.



Debug LED

LED Status Indicators

These LEDs indicate the system status.

- ❑ POWER LED (Green):
When the system is powered on, the LED is on.
- ❑ DIMM LED (Yellow):
When the memory slot has power, the LED is on.
- ❑ STANDBY LED (Blue):
When the system is in standby mode, the LED is on.
- ❑ CPU HOT LED (Red):
When the CPU is overheating, the LED is on.



POWER LED

DIMM LED

STANDBY LED

CPU HOT LED

Configuring the BIOS

This section discusses how to change the system settings through the BIOS Setup menus. Detailed descriptions of the BIOS parameters are also provided.

This section includes the following information:

- ❑ Enter BIOS Setup
- ❑ Main Menu
- ❑ Standard CMOS Features
- ❑ Advanced BIOS Features
- ❑ Advanced Chipset Features
- ❑ Integrated Peripherals
- ❑ Power Management Setup
- ❑ PnP/PCI Configurations
- ❑ PC Health Status
- ❑ Frequency/Voltage Control

Enter BIOS Setup

The BIOS is the communication bridge between hardware and software. Correctly setting the BIOS parameters is critical to maintain optimal system performance.

Use the following procedure to verify/change BIOS settings.

1. Power on the computer.
2. Press the **Del** key when the following message briefly displays at the bottom of the screen during the Power On Self Test (POST).

Press F1 to continue, DEL to enter Setup.

Pressing **Del** takes you to the Phoenix-Award BIOS CMOS Setup Utility.

It is *strongly* recommended that you do not change the default BIOS settings. Changing some settings could damage your computer.

Main Menu

The main menu allows you to select from the list of setup functions and two exit choices. Use the **Page Up** and **Page Down** keys to scroll through the options or press **Enter** to display the associated submenu. Use the **↑↓** arrow keys to position the selector in the option you choose. To go back to the previous menu, press **Esc**.

Note that on the BIOS screens all data in **white** is for information only, data in **yellow** is changeable, data in **blue** is non-changeable, and data in a **red box** is highlighted for selection.

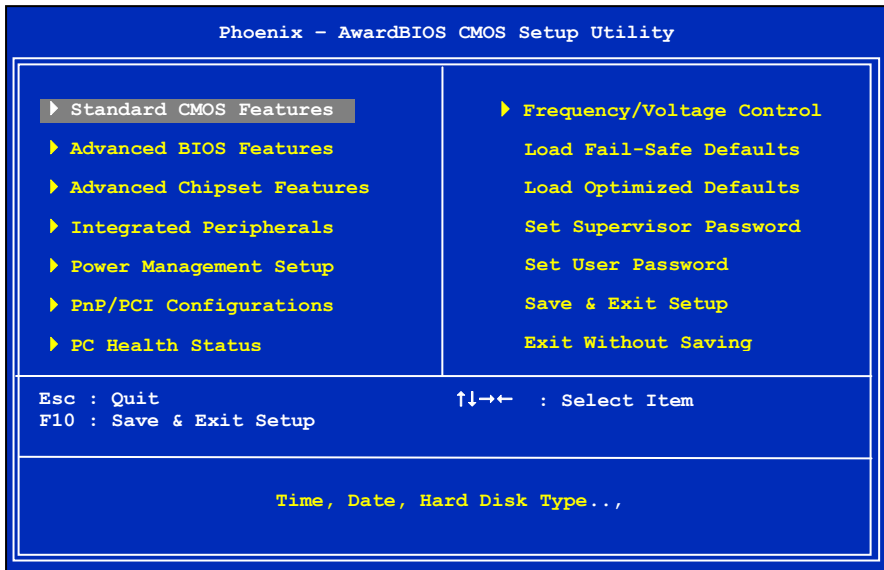

Figure 5. BIOS CMOS Setup Utility Main Menu

- ❑ **Standard CMOS Features**
Use this menu to set up the basic system configuration.
- ❑ **Advanced BIOS Features**
Use this menu to set up the advanced system features and boot sequence.
- ❑ **Advanced Chipset Features**
Use this menu to optimize system performance and configure clocks, voltages, memory timings, and more.
- ❑ **Integrated Peripherals**
Use this menu to set up onboard peripherals such as IDE, RAID, USB, LAN, and MAC control.
- ❑ **Power Management Setup**
Use this menu to configure power management, power on, and sleep features.
- ❑ **PnP/PCI Configurations**
Use this menu to modify the system's Plug-and-Play and PCI configurations.
- ❑ **PC Health Status**
Use this menu to monitor the real-time system status of your PC, including temperature, voltages, and fan speed.

The following items on the CMOS Setup Utility main menu are commands rather than submenus:

- ❑ **Load Fail-Safe Defaults**
Load Fail-Safe defaults system settings.
- ❑ **Load Optimized Defaults**
Load Optimized defaults system settings.
- ❑ **Set Supervisor Password/Set User Password**
Use this command to set, change, and disable the password used to access the BIOS menu.
- ❑ **Save & Exit Setup**
Use this command to save settings to CMOS and exit setup.
- ❑ **Exit Without Saving**
Use this command to abandon all setting changes and exit setup.

Standard CMOS Features Menu

The Standard CMOS Features menu is used to configure the standard CMOS information, such as the date, time, HDD model, and so on. Use the **Page Up** and **Page Down** keys to scroll through the options or press **Enter** to display the sub-menu. Use the **↑↓** arrow keys to position the selector in the option you choose. To go back to the previous menu, press **Esc**.

The information shown in **Item Help** corresponds to the option highlighted.

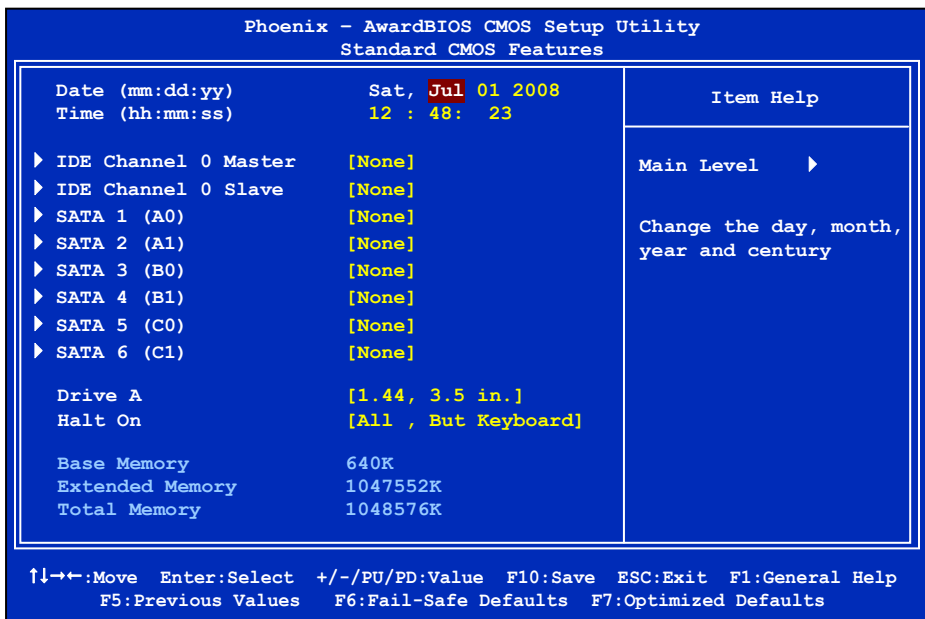

Figure 6. Standard CMOS Features Menu

Note that all data in **white** is for information only, data in **yellow** is changeable, data in **blue** is non-changeable, and data in a **red box** is highlighted for selection.

Date and Time

Using the arrow keys, position the cursor over the month, day, and year. Use the **Page Up** and **Page Down** keys to scroll through dates and times. Note that the weekday (Sun through Sat) cannot be changed. This field changes to correspond to the date you enter. Note that the hour value is shown in a 24-hour clock format. Time is represented as `hour : minute : second`

```
Date (mm:dd:yy)      Sat, Jul 01 2006
Time (hh:mm:ss)     14 : 48: 43
```

IDE Channel and SATA Channel

Use these functions to detect and configure the individual IDE and SATA channels. Select a channel and press **Enter** to display the IDE/SATA sub-menu.

```
▶ IDE Channel 0 Master  [None]
▶ IDE Channel 0 Slave  [None]
▶ SATA 1 (A0)           [None]
▶ SATA 2 (A1)           [None]
▶ SATA 3 (B0)           [None]
▶ SATA 4 (B1)           [None]
▶ SATA 5 (C0)           [None]
▶ SATA 6 (C1)           [None]
```

Press ENTER to display IDE Channel sub-menu

```
IDE HDD Auto-Detect  [Press Enter]

IDE Channel 0 Slave  [Manual]
Access Mode          [CHS]

Capacity              0 MB

Cylinder              [ 0]
Head                  [ 0]
Precomp               [ 0]
Landing Zone         [ 0]
Sector                [ 0]
```

Press ENTER to display SATA Channel sub-menu

```
IDE Auto-Detect      [Press Enter]

Extended IDE Drive   [None]
Access Mode          Auto

Capacity              0 MB

Cylinder              0
Head                  0
Precomp               0
Landing Zone         0
Sector                0
```

Press **Enter** to auto-detect IDE and SATA channels in the system. Once the channel is detected, the values for Capacity, Cylinder, Heads, Precomp, Landing Zone, and Sector are automatically filled in.

- ❑ **None**
There is no HDD installed or set.
- ❑ **Auto**
The system can auto-detect the hard disk when booting up.
- ❑ **Manual**
When you set the channel to **[Manual]** and change **Access Mode** to **[CHS]**, you can then enter the number of cylinders, heads, Precomp, landing zone, and sector. You can manually enter the values or you can press **Enter** to display a window that tells you the min and max values.

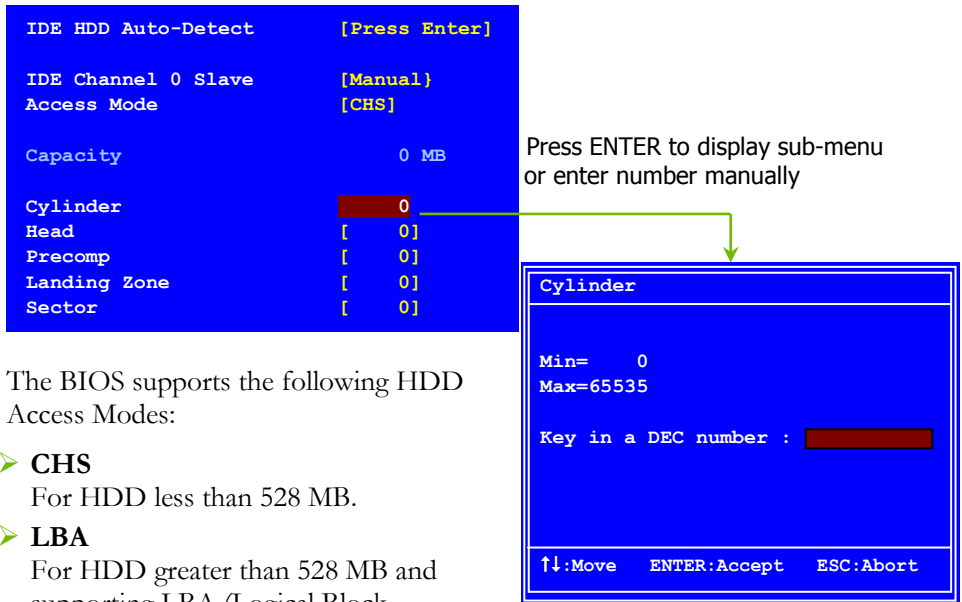

The BIOS supports the following HDD Access Modes:

- **CHS**
For HDD less than 528 MB.
- **LBA**
For HDD greater than 528 MB and supporting LBA (Logical Block Addressing).
- **Large**
For HDD greater than 528 MB but not supporting LBA.
- **Auto**
Recommended mode.

Drive A

The **Drive A** option allows you to select the kind of FDD to install. Options are:

Press ENTER to display sub-menu

```
Drive A          [1.44, 3.5 in.]
Halt On         [All , But Keyboard]
```

- None
- 360K, 5.25 in.
- 1.2M, 5.25 in.
- 720K, 3.5 in.
- 1.44M, 3.5 in.
- 2.88M, 3.5 in.

```
Drive A
None          ..... [ ]
360K, 5.25 in. .... [ ]
1.2M, 5.25 in. .... [ ]
720K, 3.5 in.  .... [ ]
1.44M, 3.5 in. .... [■]
2.88M, 3.5 in. .... [ ]

↑↓:Move  ENTER:Accept  ESC:Abort
```

Use the **Page Up** and **Page Down** keys to scroll through the options or press **Enter** to display the sub-menu. Use the **↑↓** arrow keys to position the selector in the option you choose. Press **Enter** to accept the changes and return to the Standard CMOS Features menu.

Halt On

Halt On determines whether or not the computer stops if an error is detected during power on. Use the **Page Up** and **Page Down** keys to scroll through the options or press **Enter** to display the **Halt On** sub-menu. Use the **↑↓** arrow keys to position the selector in the option you choose. Press **Enter** to accept the changes and return to the Standard CMOS Features menu.

```
Drive A          [1.44, 3.5 in.]
Halt On         [All , But Keyboard]
```

Press ENTER to display sub-menu

- All Errors**
Whenever the BIOS detects a nonfatal error, the system stops and prompts you.
- No Errors**
System boot does not stop for any detected errors.
- All, But Keyboard**
System boot does not stop for keyboard errors, but does stop for all other errors.
- All, But Diskette**
The system boot does not stop for a diskette error but will stop for all other errors.
- All, But Disk/Key**
The system boot does not stop for a keyboard or disk error, but will stop for all other errors.

```
Halt On
All Errors     ..... [ ]
No Errors      ..... [ ]
All , But Keyboard ..... [■]
All , But Diskette ..... [ ]
All , But Disk/Key ..... [ ]

↑↓:Move  ENTER:Accept  ESC:Abort
```

Memory

These settings are *display-only values* that are determined by the BIOS POST (Power-On Self Test).

Base Memory	640K
Extended Memory	1047552K
Total Memory	1048576K

- ❑ Base Memory
BIOS POST determines the amount of base (or conventional) memory installed in the system.
- ❑ Extended Memory
BIOS determines how much extended memory is present during the POST.
- ❑ Total Memory
This value represents the total memory of the system.

Advanced BIOS Features

Access the Advanced BIOS Features menu from the CMOS Utility Setup screen. Use the **Page Up** and **Page Down** keys to scroll through the options or press **Enter** to display the sub-menu. Use the **↑↓** arrow keys to position the selector in the option you choose. To go back to the previous menu, press **Esc**.

The options that have associated sub-menus are designated by a **▶**, which precedes the option. Press **Enter** to display the sub-menus.

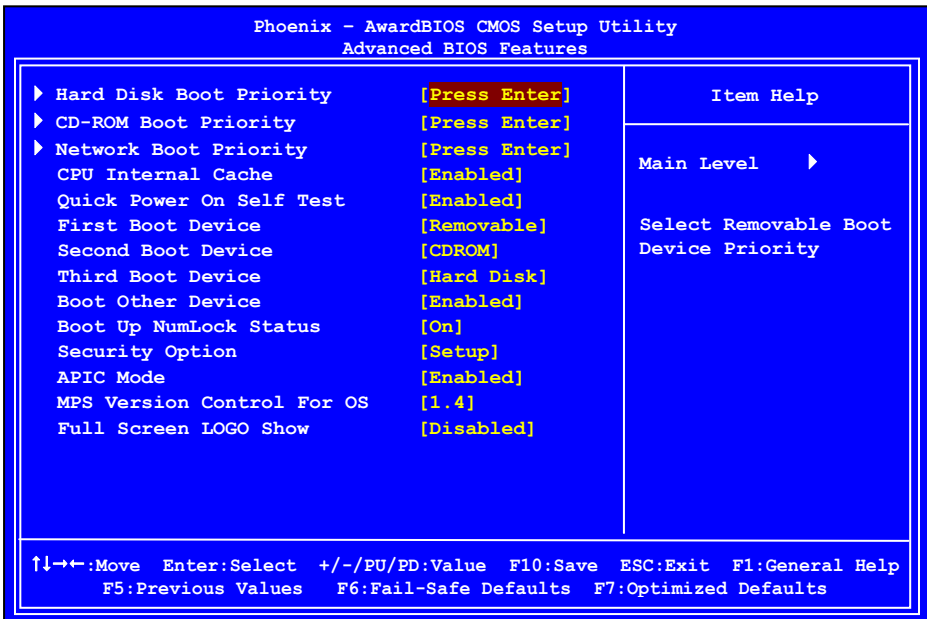

Figure 7. Advanced BIOS Features Menu

Note that all data in **white** is for information only, data in **yellow** is changeable, data in **blue** is non-changeable, and data in a **red box** is highlighted for selection.

Hard Disk Boot Priority

Use this option to select the priority for HDD startup. Press **Enter** to see the list of bootable devices in your system. Use the **↑↓** arrow keys to go to the various devices. Then use the **+** or **-** keys to move the device priority up or down in the list. To go back to the previous menu, press **Esc**.

```
1. Ch0.      : ST3802110A
2. Bootable Add-in Cards
```

Use the **+** and **-** keys to move the priority of the device within the list

CD-ROM Device Priority

Use this option to select the priority for CD-ROM startup. Press **Enter** to see the list of removable devices in your system. Use the **↑↓** arrow keys to go to the various devices. Then use the **+** or **-** keys to move the device priority up or down in the list. To go back to the previous menu, press **Esc**.

```
1. Ch0 M.    : BENQ DVD DC DW1810
```

Network Boot Priority

Use this option to select the priority for network startup. Select **Network Boot Priority** and press **Enter** to view available networks. Use the **↑↓** arrow keys to go to the various devices. Then use the **+** or **-** keys to move the device priority up or down in the list. To go back to the previous menu, press **Esc**.

```
1. Network 0 : <description of network>
2. Network 1 : <description of network>
```

CPU Internal Cache

Use this option to enable or disable the CPU internal cache. Use the **Page Up** and **Page Down** keys to scroll through the options or press **Enter** to display the options in a sub-menu. Use the **↑↓** arrow keys to position the selector in the option you choose.

Quick Power On Self Test

Enabling this option allows the system to skip certain test while booting, which reduces the time needed to boot the system. Use the **Page Up** and **Page Down** keys to toggle between **Enable** and **Disable**.

First/Second/Third Boot Device

Use this option to set the priority sequence of the devices booted at power on. Use the **Page Up** and **Page Down** keys to scroll through the options or press **Enter** to display the sub-menu. Use the **↑↓** arrow keys to position the selector in the option you choose.

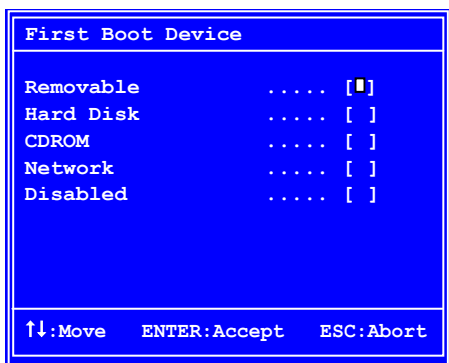

Boot Other Device

With the option set to **Enable**, the system boots from some other device if the first/second/third boot devices fail.

Boot Up NumLock Status

This option allows you to select the power-on state of **NumLock**. Select **on** to activate the keyboard **NumLock** when the system is started. Select **off** to disable the **NumLock** key.

Security Option

The Security Options allows you to require a password every time the system boots or only when you enter setup. Select **Setup** to require a password to gain access to the CMOS Setup screen. Select **System** to require a password to access the CMOS Setup screen and when the system boots.

APIC Mode

Use this function to enable or disable the Advanced Programmable Interrupt Controller (APIC). If you disable this option, you also disable the MPS Version Control for OS option.

MPS Version Control For OS

Use this function to select the Multi-Processor Specification (MPS) version that BIOS passes to the operating system. Use the **Page Up** and **Page Down** keys to scroll through the options.

Full Screen LOGO Show

This option allows you to enable or disable the display of the full-screen logo when the system boots. Use the **Page Up** and **Page Down** keys to toggle between **Enable** and **Disable**

Advanced Chipset Features

Select **Advanced Chipset Features** from the CMOS Setup Utility menu and press **Enter** to display the functions of the Advanced Chipset Functions menu.

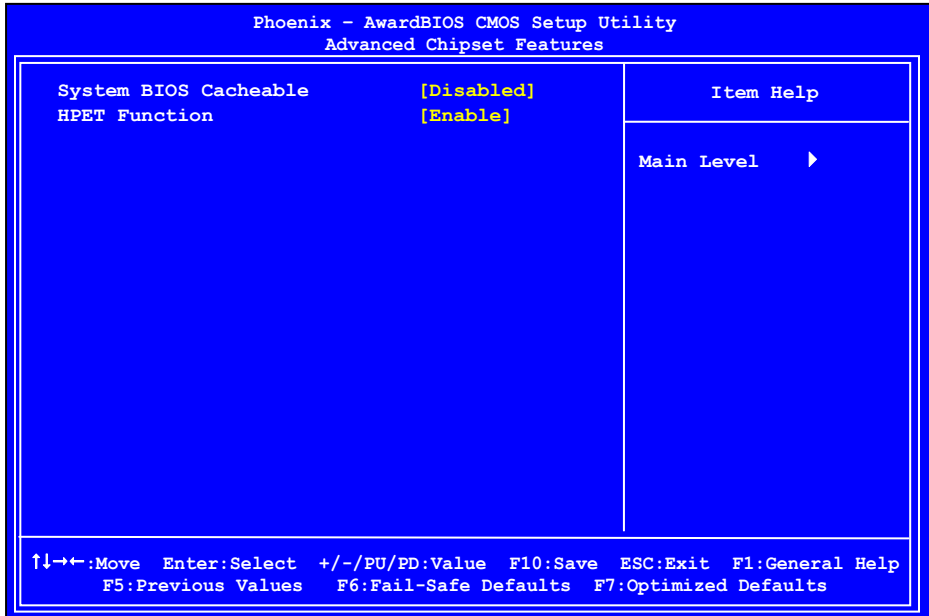

Figure 8. Advanced Chipset Features

System BIOS Cacheable

This function allows you to enable or disable caching the system BIOS.

HPET Function

This function allows you to enable or disable the High Precision Even Timer (HPET). When **Enabled**, HPET is used as the timing hardware for multimedia and other time-sensitive application. When HPET is **Disabled**, the APIC timer is used.

Integrated Peripherals Menu

Select **Integrated Peripherals** from the CMOS Setup Utility menu and press **Enter** to display the Integrated Peripherals menu.

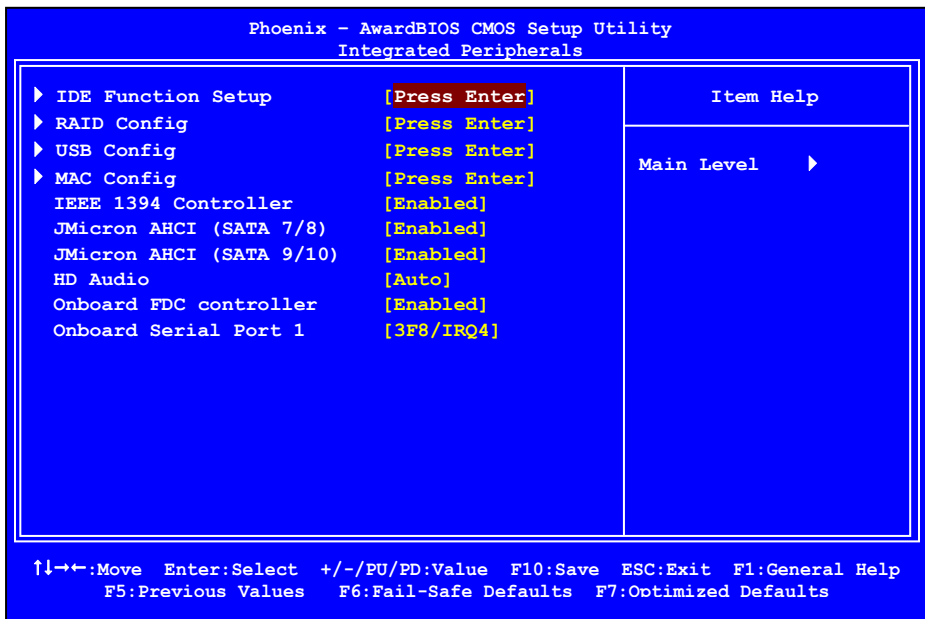

Figure 9. Integrated Peripherals Menu

IDE Function Setup

Press **Enter** to display the IDE Function Setup menu.

```
OnChip IDE Channel0      [Enabled]
Primary Master   PIO      [Auto]
Primary Slave    PIO      [Auto]
Primary Master   UDMA     [Auto]
Primary Slave    UDMA     [Auto]
IDE DMA transfer access [Enabled]
Serial-ATA Controller [All Enabled]
IDE Prefetch Mode [Enabled]
IDE HDD Block Mode [Enabled]
```

- ❑ **OnChip IDE Channel0**
Use this function to enable or disable the onchip IDE Channel0. When disabled, the Primary Master/Slave functions are changed to **Auto** and cannot be changed.

```
OnChip IDE Channel0      [Disabled]
x Primary Master   PIO      Auto
x Primary Slave    PIO      Auto
x Primary Master   UDMA     Auto
x Primary Slave    UDMA     Auto
IDE DMA transfer access [Enabled]
Serial-ATA Controller [All Enabled]
IDE Prefetch Mode [Enabled]
IDE HDD Block Mode [Enabled]
```

- ❑ **Primary Master/Slave PIO**
When **OnChip IDE Channel0** is set to **[Enabled]**, you can select a mode for the primary Master and Slave PIO. Select from **Auto**, or **Mode 1** through **Mode 4**.
- ❑ **Primary Master/Slave UDMA**
When **OnChip IDE Channel0** is set to **[Enabled]**, you can disable the primary Master and Slave UDMA or set it to **[Auto]**.
- ❑ **IDE DMA transfer access**
Use this function to enable or disable IDE DMA transfer access.
- ❑ **Serial-ATA Controller**
This function allows you to enable specific SATA controllers. The options available are **[SATA-0]**, **[SATA-0+1]**, **[Enabled]**, and **[Disabled]**.
- ❑ **IDE Prefetch Mode**
Use this function to enable or disable the IDE Prefetch mode.

❑ IDE HDD Block Mode

Using this function on the Integrated Peripherals menu allows your IDE hard drive needs to support block mode. Select **[Enabled]** to automatically detect the optimal number of block read/writes per sector the drive can support. Select **[Disabled]** if your drive does not support block mode.

RAID Config

Press **Enter** to display the RAID Config menu.

RAID Enable	[Enabled]
SATA 1 (A0) RAID	[Disabled]
SATA 2 (A1) RAID	[Disabled]
SATA 3 (B0) RAID	[Disabled]
SATA 4 (B1) RAID	[Disabled]
SATA 5 (C0) RAID	[Disabled]
SATA 6 (C1) RAID	[Disabled]

❑ RAID Enable

Use this function to enable or disable RAID. When RAID is set to **[Disabled]**, all SATA functions are changed to **Disabled** and cannot be changed.

RAID Enable	[Disabled]
x SATA 1 (A0) RAID	Disabled
x SATA 2 (A1) RAID	Disabled
x SATA 3 (B0) RAID	Disabled
x SATA 4 (B1) RAID	Disabled
x SATA 5 (C0) RAID	Disabled
x SATA 6 (C1) RAID	Disabled

- ❑ **SATA x Primary/Secondary** When **RAID Enable** is set to **[Enabled]**, you can enable or disable the various SATA functions.

USB Config

Press **Enter** to display the USB Config menu.

OnChip USB	[V1.1+V2.0]
USB Keyboard Support	[Enabled]
USB Mouse Support	[Enabled]

❑ OnChip USB

Use this function to enable specific versions of the USB or disable the onchip USB. When the onchip USB is set to **[Disabled]**, the keyboard and mouse support functions are set to **V1.1+V2.0** and cannot be changed. Versions that can be selected are **[V1.1+V2.0]** or **[V1.1]**.

OnChip USB	[Disabled]
x USB Keyboard Support	Enabled
x USB Mouse Support	Enabled

❑ **USB Keyboard/Mouse Support**

Use these function to enable or disable the onchip USB support of the keyboard and/or mouse.

MAC Config

Press **Enter** to display the MAC Config menu.



❑ **MACx LAN**

Use these functions to set the MAC0 and/or MAC1 LANs to **Auto** or disable their functions.

IEEE 1394a Controller

This function on the Integrated Peripherals menu allows you to enable or disable the IEEE 1394a (*Firewire*) interface.

JMicron AHCI (SATA 7/8)

This function on the Integrated Peripherals menu allows you to enable or disable SATA port 7 and 8(eSATA).

JMicron AHCI (SATA 7/8)

This function on the Integrated Peripherals menu allows you to enable or disable SATA port 9 and 10.

HD Audio

This function on the Integrated Peripherals menu allows you to enable or disable the high-definition audio function.

Onboard FDC Controller

This function on the Integrated Peripherals menu allows you to enable or disable the onboard FDC controller function.

Onboard Serial Port 1

This function on the Integrated Peripherals menu allows you to select the onboard serial port 1 function. Options are [**3F8/IRQ4**], [**2E8/IRQ3**], [**3E8/IRQ4**], [**Auto**], and [**Disabled**].

Power Management Setup Menu

Select **Power Management Setup** from the CMOS Setup Utility menu and press **Enter** to display the Power Management Setup menu.

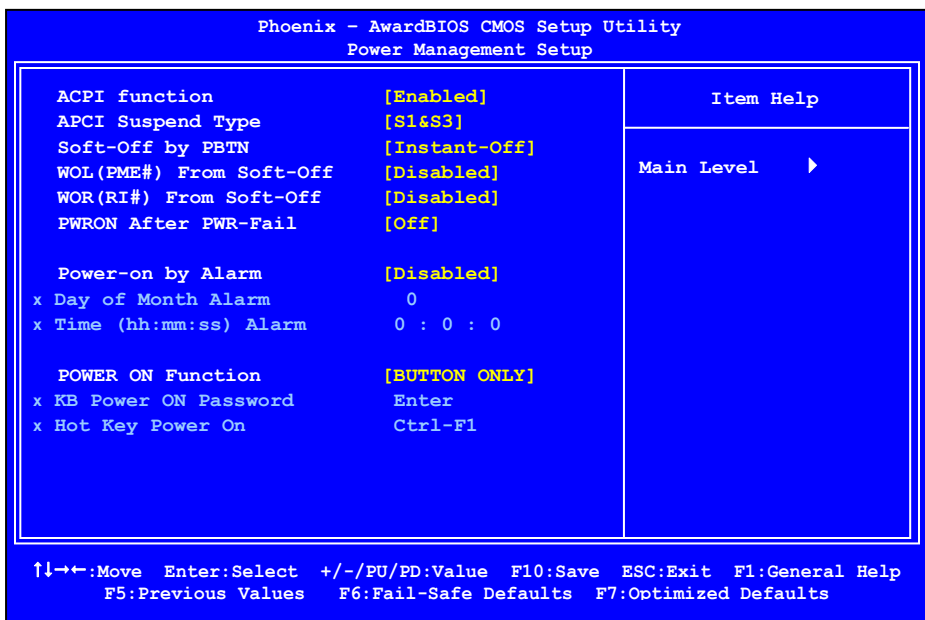

Figure 10. Power Management Setup Menu

ACPI Function

This function on the Power Management Setup menu allows you to enable or disable the ACPI function.

ACPI Suspend Type

This function on the Power Management Setup menu allows you to select an ACPI Suspend Type. Types to select from are **[S1&S3]**, **[S1 (POS)]**, and **[S3 (STR)]**.

Soft-Off by PBNT

This function on the Power Management Setup menu allows you to set Soft-Off by PBNT to **[Instant-Off]** or **[Delay 4 Sec]**.

WOL(PME#) From Soft-Off

This function on the Power Management Setup menu allows you to enable or disable WOL(PME#) from soft-off.

WOR(RI#) From Soft-Off

This function on the Power Management Setup menu allows you to enable or disable WOR(RI#) from soft-off.

PWRON After PWR-Fail

- ❑ This function enables your computer to automatically restart or return to its last operating status after power returns from a power failure.
- ❑ Off: The system stays off after a power failure.
- ❑ On: The system stays on after a power failure

Power On by Alarm

This function on the Power Management Setup menu allows you to enable or disable the Power-on by alarm function. Set to **[Disable]** to prevent power-on by alarm. When set to **[Enable]**, you can manually put in the day of the month and the time of the alarm.

```
Power-on by Alarm      [Disabled]
Day of Month Alarm    [ 0 ]
Time (hh:mm:ss) Alarm [0 : 0 : 0]
```

To enter a day or time, use the **Page Up** and **Page Down** keys to scroll through numbers or enter the number using the keyboard number or the **+** and **-** keys.

POWER ON Function

This function on the Power Management Setup menu allows you to define the power-on function. Options for this function are:

- BUTTON ONLY**
- Keyboard 98**
- Password**

When [**Password**] is selected, the **KB Power ON Password** function is enabled so that you must enter a password.

```
POWER ON Function      [Password]
KB Power ON Password   [Enter]
x Hot Key Power On     Ctrl-F1
```

Hot Key Power On

When [**Hot Key**] is selected, the **Hot key Power On** function is enabled so that you must select a keyboard key as the hot key. To select a hot key use **Ctrl+F1** though **Ctrl+F12**

```
POWER ON Function      [Hot key]
x KB Power ON Password Enter
Hot Key Power On       [Ctrl-F1]
```

Mouse Left

- Mouse Right**
- Any Key**

PnP/PCI Configuration Menu

Select **PnP/PCI Configuration** from the CMOS Setup Utility menu and press **Enter** to display the PnP/PCI Configuration menu.

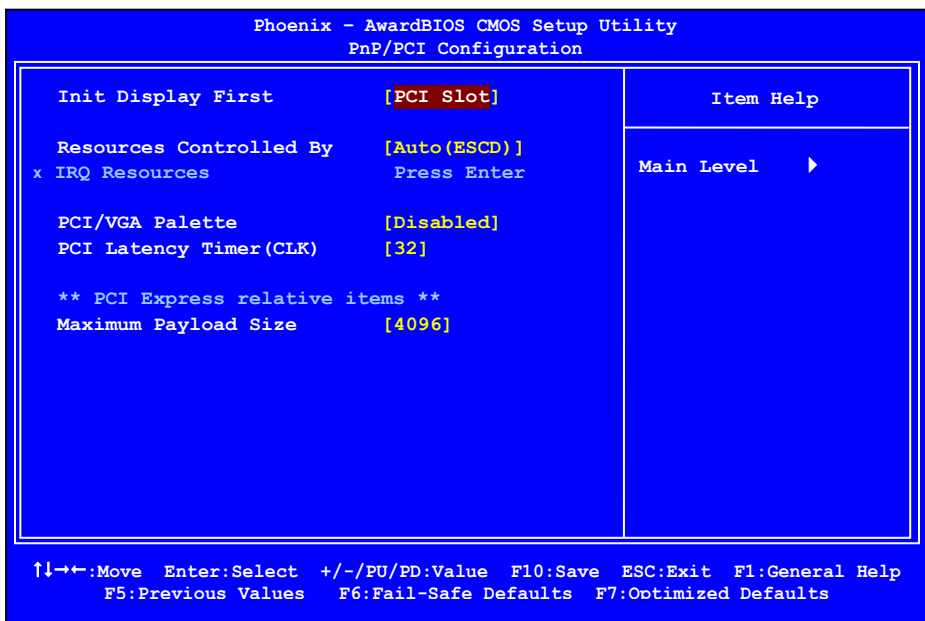

Figure 11. PnP/PCI Configuration Menu

Init Display First

This function on the PnP/PCI Configuration menu allows you to define if the initial display is in the PCI slot or in the PCI Express slot. Options are **[PCI Slot]** and **[PCIEx]**.

Resources Controlled By

This function on the PnP/PCI Configuration menu allows you to define if the BIOS can automatically configure all the boot and plug-and-play compatible devices or if you can manually select IRQ, DMA, and memory base address fields. Select **[Auto (ESCD)]** if you want the BIOS to automatically populate these fields. If you select **[Manual]** so you can assign the resources, **IRQ Resources** is enabled for input.

```
Resources Controlled By [Auto (ESCD)]
x IRQ Resources          Press Enter
```

```
Resources Controlled By [Manual]
IRQ Resources           [Press Enter]
```

IRQ Resources

To enable this field for input, set **Resources Controlled By** to **[Manual]**. With this field enabled, press **Enter** to see options.

```
IRQ-5 assigned to [PCI Device]
IRQ-9 assigned to [Reserved]
IRQ-10 assigned to [PCI Device]
IRQ-11 assigned to [PCI Device]
IRQ-14 assigned to [PCI Device]
IRQ-15 assigned to [PCI Device]
```

Use Legacy ISA for devices compliant with the original PC AT Bus specification.
Use PCI/ISA PnP for devices compliant with the plug-and-play standard, whether designed for PCI or ISA Bus architecture.

PCI/VGA Palette Snoop

This item is designed to overcome problems that may be caused by some nonstandard VGA cards..

PCI Latency Timer (CLK)

This item controls how long each PCI device can hold the bus before another takes over. When set to higher values, every PCI device can conduct transactions for a longer time and thus improve the effective PCI bandwidth. For better PCI performance, you should set the item to higher values. The options are 0 through 255.

Maximum Payload Size

This function on the PnP/PCI Configuration menu allows you to set the maximum TLP payload size (in bytes) for the PCI Express devices. Use the **Page Up** and **Page Down** keys to scroll through sizes or enter the number using the keyboard numbers or use the **+** and **-** keys to go up and down the list of sizes.

PC Health Status Menu

Select **PC Health Status** from the CMOS Setup Utility menu and press **Enter** to display the PC Health Status menu.

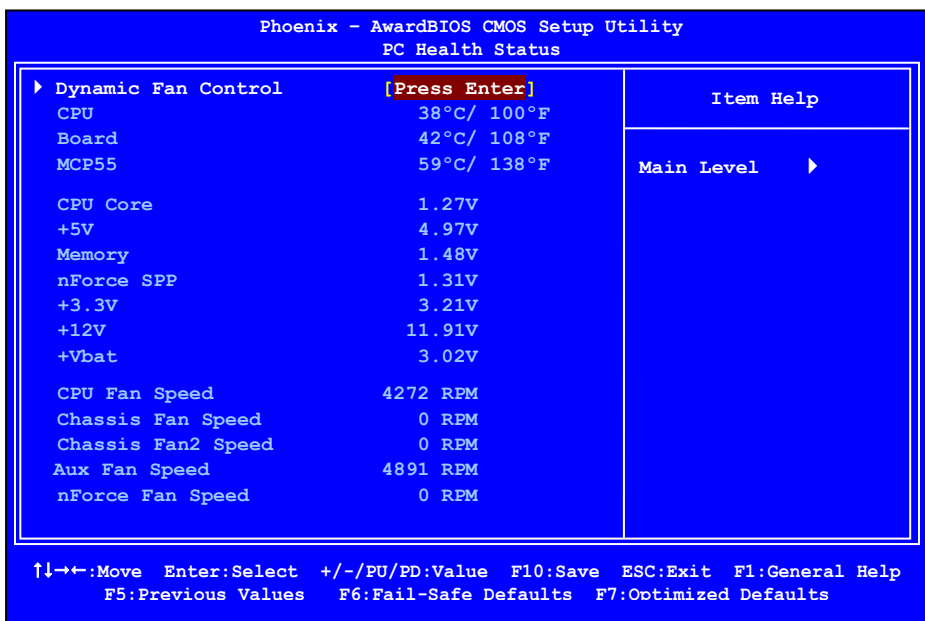

Figure 12. PC Health Status Menu

All of the values shown in **Blue** are dynamic and change as the speed and voltages of the various components change with system usage.

Dynamic Fan Control

Press **Enter** to display the Dynamic Fan Control menu.

```
CPU Fan Speed Control      [SmartFan]
If temp > 70°C, Set Fan Speed 100%
If temp < 30°C, Set Fan Speed 1%
x Manual Fan Speed, %      100

Chassis Fan Speed Control  [SmartFan]
If temp > 70°C, Set Fan Speed 100%
If temp < 30°C, Set Fan Speed 1%
x Manual Fan Speed, %      100

nForce Fan Speed Control   [Auto]
x Manual Fan Speed, %      100

AUX Fan Speed Ctrl, %      [100]
Chassis Fan2 Speed Ctrl, % [100]

CPU VREG Fan Control       [on]
```

Use this menu to control the speed of the various fans on the motherboard. Set CPU fan speed to **[SmartFan]** when you want the speed of the fans automatically controlled based on temperature. To set the fan speed to a constant rate, select **[Manual]** and then enter the speed from 0% to 100%.

Set the desired speed for the Aux, nForce, and Chassis fans from 0% to 100%. The system defaults to 100%.

Frequency/Voltage Control Menu

Select **Frequency/Voltage Control** from the CMOS Setup Utility menu and press **Enter** to display the Frequency/Voltage Control menu.

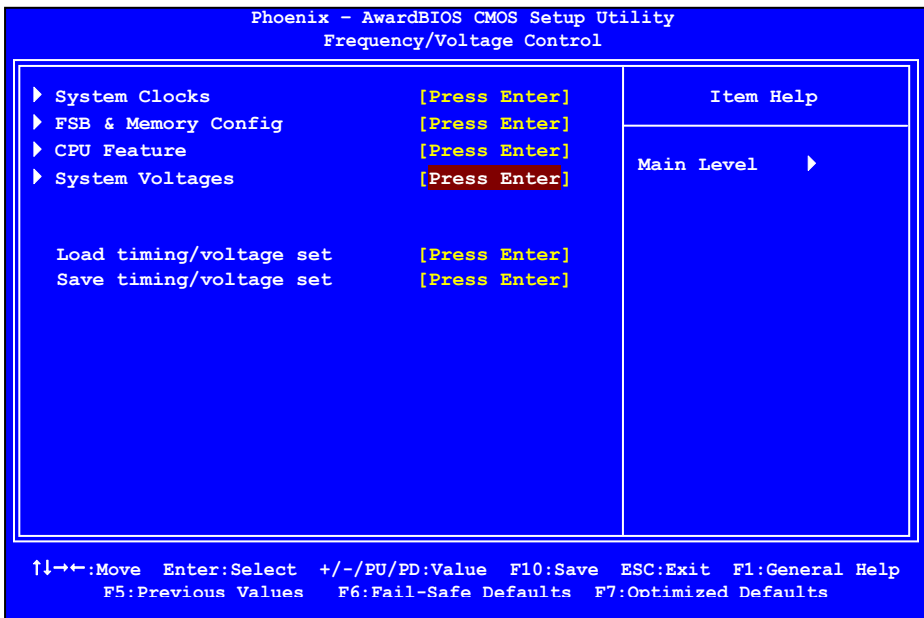

Figure 13. Frequency/Voltage Control Menu

System Clocks

Select **System Clocks** from the Frequency/Voltage Control menu and press **Enter** to display the System Clocks menu. From this menu, you are able to specify frequency settings, HT multipliers, and Spread Spectrum settings. Note that in Figure 9, all of the options are listed. On the actual BIOS screen, you will need to scroll down to see all the options.

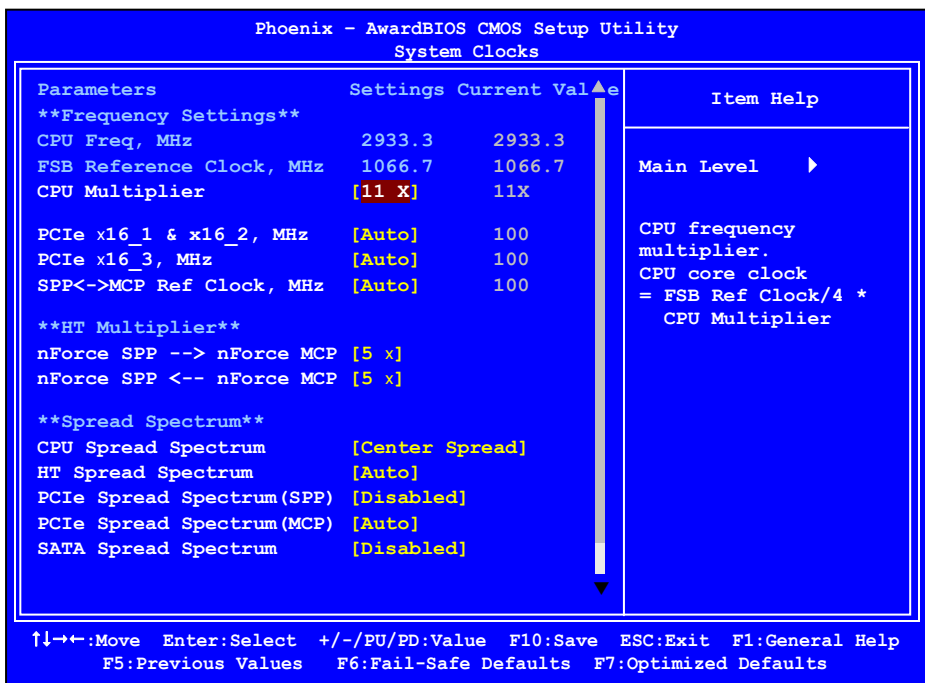

Figure 14. System Clocks Menu

Note that all data in **white** is for information only, data in **yellow** is changeable, data in **blue** is non-changeable, and data in a **red box** is highlighted for selection.

Frequency Settings

- ❑ **CPU Freq, MHz**
This value is set by the CPU Multiplier (value cannot be changed by the user).
- ❑ **FSB Reference Clock, MHz**
This value is set by the system (value cannot be changed by the user). To change the SLI-Ready memory, FSB memory, and memory timing, go to the FSB & Memory screen.
- ❑ **CPU Multiplier**
This value changes the CPU Frequency value depending on the value you choose. Use the **Page Up** and **Page Down** keys to scroll through the options. The options are from 6 X through 60 X.
- ❑ **PCIe x16_1, MHz & PCIe x16_2, MHz**
Use the **Page Up** and **Page Down** keys to scroll through the frequency options for the PCI Express Bus, Slot 1 (the black slot closest to the CPU) and Slot 2 (the black slot farthest from the CPU). Note that as you go higher in value, **PCIe Spread Spectrum (SPP)** is disabled and cannot be changed from this status.
- ❑ **PCIe x16_3, MHz**
Use the **Page Up** and **Page Down** keys to scroll through the frequency options for the PCI Express Bus, Slot 3 (the blue slot in the middle).
- ❑ **SPP<—>MCP Ref Clock, MHz**
Use the **Page Up** and **Page Down** keys to scroll through the frequency options for the reference clock between the SPP chip and the MCP chip.

HT Multiplier

- ❑ **nForce SPP —> nForce MCP**
Use the **Page Up** and **Page Down** keys to scroll through the HT multiplier options and set the link speed from the SPP chip to the MCP chip. Values are [1 x] through [5 x].
- ❑ **nForce MCP <— nForce SPP**
Use the **Page Up** and **Page Down** keys to scroll through the HT multiplier options and set the link speed from the MCP chip to the SPP chip. Values are [1 x] through [5 x].

Spread Spectrum Setting

- ❑ **CPU Spread Spectrum**

This option reduces the EMI generated by the CPU. Options are [Disabled] and [Center Spread].

- ❑ **HT Spread Spectrum**

This option reduces the EMI generated by the HT. Options are [Disabled] and [Auto].

- ❑ **PCIe Spread Spectrum (SPP)**

This option reduces the EMI generated by the SPP PCI-E. Options are [Disabled] and [Auto]. This option reverts to **Disabled** and cannot be changed when the value for PCIe x16_1 exceeds 100MHz.

- ❑ **PCIe Spread Spectrum(MCP)**

This option reduces the EMI generated by the PCI-E. Options are [Disabled] and [Auto]

- ❑ **SATA Spread Spectrum**

This option reduces the EMI generated by the S-ATA. Options are [Disabled] and [Down Spread].

FSB & Memory Config

Select **FSB & Memory Config** from the Frequency/Voltage Control menu and press **Enter** to display the FSB & Memory Config menu. This menu provides the means to set SLI-Ready memory, FSB memory, and memory timing.

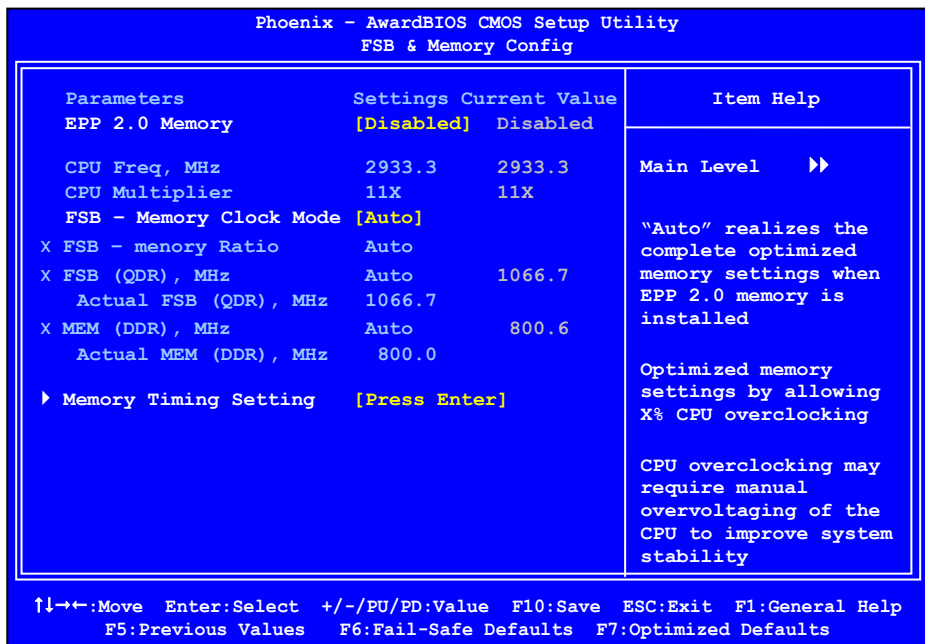

Figure 15. FSB & Memory Config Menu

❑ EPP 2.0 Memory

Use the **Page Up** and **Page Down** keys to scroll through the EPP 2.0 Memory options. The options are:

- Disabled
- CPUOC 0%
- CPUOC 1%
- CPUOC 2%
- CPUOC 3%
- CPUOC 4%
- CPUOC 5%
- Auto
- Expert

When you select one of the **CPUOC x%** options, the **FSB - Memory Clock Mode** is set to **Unlinked** and cannot be changed until **EPP 2.0 Memory** is set to **Disable**.

❑ **FSB and Memory Clock Mode**

Use the **Page Up** and **Page Down** keys to scroll through the FSB and Memory Clock Mode options. The options are:

➤ **Auto**

This is the optimal setting since it sets the FSB and memory speeds automatically.

➤ **Linked**

When **Link** is selected, **FSB-Memory Ratio** and **FSB (QDR), MHz** are changed to editable and the FSB speed can be entered manually. As the FSB speed is changed, **CPU Freq, MHz** changes proportionally.

CPU Freq, MHz	2933.3	2933.3
CPU Multiplier	11X	11X
FSB - Memory Clock Mode	[Linked]	
FSB - Memory Ratio	[Auto]	
FSB (QDR), MHz	[1067]	1066.7
Actual FSB (QDR), MHz	1066.7	
X MEM (DDR), MHz	Auto	800.6

➤ **Unlinked**

When **Unlink** is selected, **FSB (QDR), MHz** and **MEM (DDR), MHz** are changed to editable and the FSB and memory speeds can be entered manually. As the FSB speed is changed, **CPU Freq, MHz** changes proportionally.

FSB - Memory Clock Mode	[Unlinked]	
X FSB - Memory Ratio	Auto	
FSB (QDR), MHz	[1067]	1066.7
Actual FSB (QDR), MHz	1066.7	
MEM (DDR), MHz	[1067]	800.6
Actual MEM (DDR), MHz	800.0	

❑ **FSB (QDR), MHz**

Use the **+** or **-** keys to scroll through new values for the CPU FSB frequency or type in a new value. Note that the **Actual FSB (QDR)** reflects the actual frequency that takes effect on a reboot.

❑ **MEM (DDR), MHz**

Use the **+** or **-** keys to scroll through new values for the memory frequency or type in a new value. Note that the **Actual MEM (DDR)** reflects the actual frequency that takes effect when the system reboots.

❑ **Memory Timing Setting**

Press **Enter** to display the Memory Timing Setting menu. Use this menu to set optimal timings or to manually enter timings.

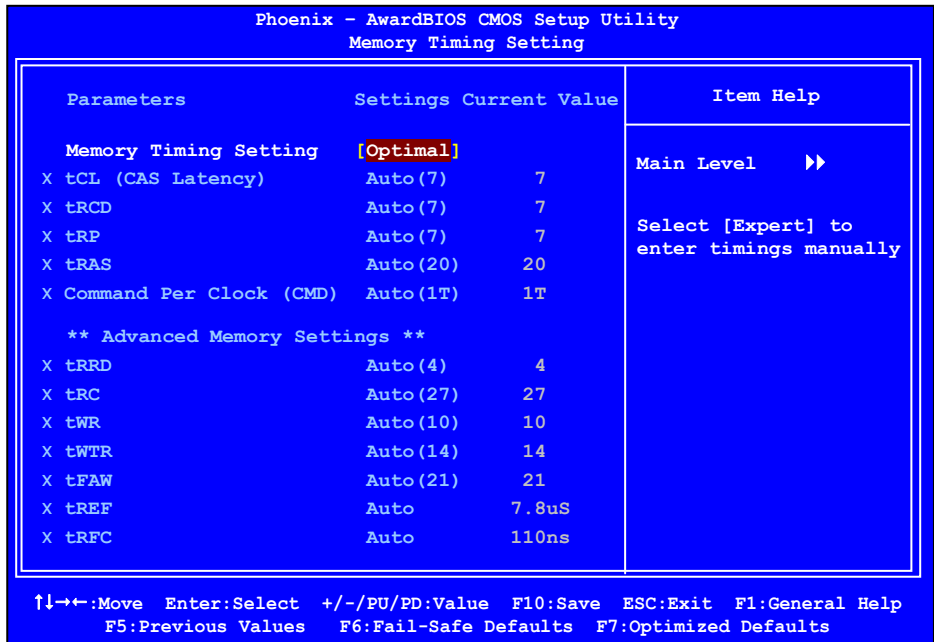

➤ **Optimal**

Use the **Page Up** and **Page Down** keys to select **Optimal**. Optimal prohibits you from manually setting any timing. All timing is set for optimal performance.

➤ Expert

Use the **Page Up** and **Page Down** keys to select **Expert**. When Expert is selected, all timing categories are enabled for manual input. Note that you should set the value to Optimal to use the manufacturers' recommended values.

Parameters	Settings	Current Value
Memory Timing Setting	[Expert]	
tCL (CAS Latency)	[Auto (7)]	7
tRCD	[Auto (7)]	7
tRP	[Auto (7)]	7
tRAS	[Auto (20)]	20
Command Per Clock (CMD)	[Auto (1T)]	1T
** Advanced Memory Settings **		
tRRD	[Auto (4)]	4
tRC	[Auto (27)]	27
tWR	[Auto (10)]	10
tWTR	[Auto (14)]	14
tFAW	[Auto (21)]	21
tREF	[Auto]	7.8uS
tRFC	[Auto]	110ns

tCL: CAS# latency (options are Auto and 5 through 18).

tRCD: RAS#-to-CAS# Delay for Read/Write commands to the same bank (options are Auto and 1 through 15).

tRP: Row Precharge time. This is the Precharge-to-Active or Auto-to-Refresh of the same bank (options are Auto and 1 through 15).

tRAS: This is the minimum RAS# active time (options are Auto and 1 through 63).

Command Per Clock: This is the command timing setting on a per clock unit basis (options are Auto, 1 clock and 2 clock).

tRRD: RAS#-to-RAS# delay of different banks (options are Auto and 1 through 15).

tRC: RAS#-to-RAS# or auto refresh time of the same bank (options are Auto and 1 through 63).

tWR: The Write recovery time (options are Auto and 5 through 12).

tWTR: This is the minimum write-to-read delay with the same chip selected (options are Auto and 1 through 31).

tFAW: Minimum four Activate Windows delay time (options are Auto and 1 through 63).

tREF: This is the DRAM refresh rate (options are **Auto**, **7.8uS**, and **3.9uS**).

tRFC: Minimum Refresh Recover Time Delay (options are **Auto**, **90ns**, **110ns**, **160ns** and **285ns**).

CPU Feature

Select **CPU Feature** from the Frequency/Voltage Control menu and press **Enter** to display the CPU Feature menu.

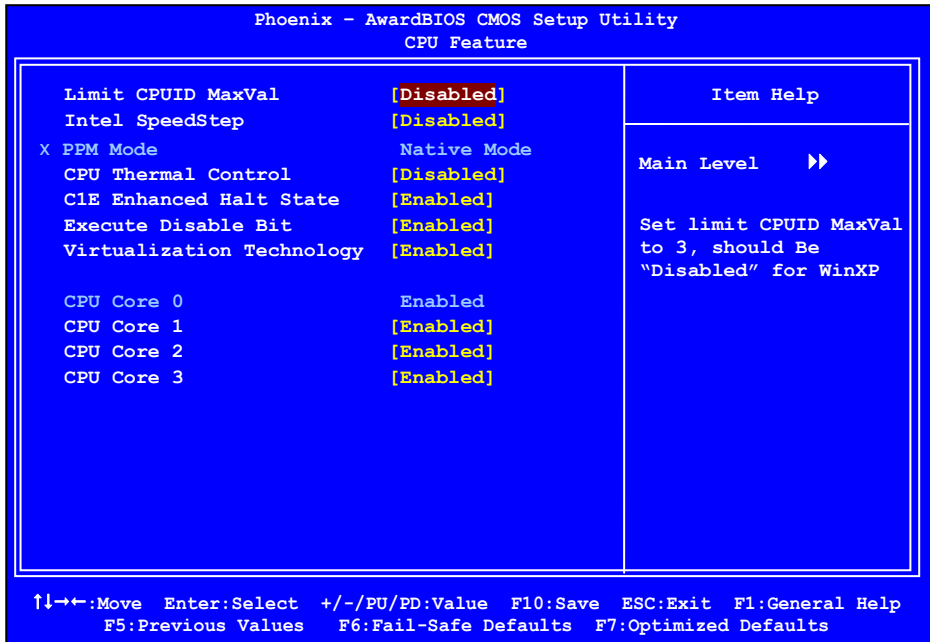

Figure 16. CPU Feature Menu

- ❑ **Limit CPUID MaxVal**
Use this function to enable the set limit of the CPUID MaxVal to 3. Set to Disable for Win XP.
- ❑ **Intel SpeedStep**
Use this function to enable the Intel SpeedStep technology (EIST). When set to "Auto" the below item become available to set [Native Mode] or [SMM Mode] for PPM Mode

CPU Thermal Control

Use this function to enable or disable TM1 and TM2 support. Options are:

- **Disable**
Disable support for TM1 and TM2.
- **TM1 Only**
The CPU is thermally throttled by cutting active processor clock cycles.
- **TM2 Only**
Thermal throttling is achieved by reducing the CPU multiplier and CPU core voltage.
- **TM1 & TM2**
Enables support for both TM1 and TM2.

C1E Enhanced Halt State

When set to enabled, this function reduces the CPU power consumption when the CPU is idle. Idle occurs when the operating system issues a halt instruction.

Execute Disable Bit

When this function is disabled, it forces the XD feature flag to always return to zero (0).

Virtualization Technology

When this function is enabled, it allows a VMM to utilize the additional hardware capabilities provided by Intel Virtualization Technology.

CPU Core 0/1/2/3

This function allows you to enable or disable CPU Core.

System Voltages

Select **System Voltages** from the Frequency/Voltage Control menu and press **Enter** to display the System Voltages menu.

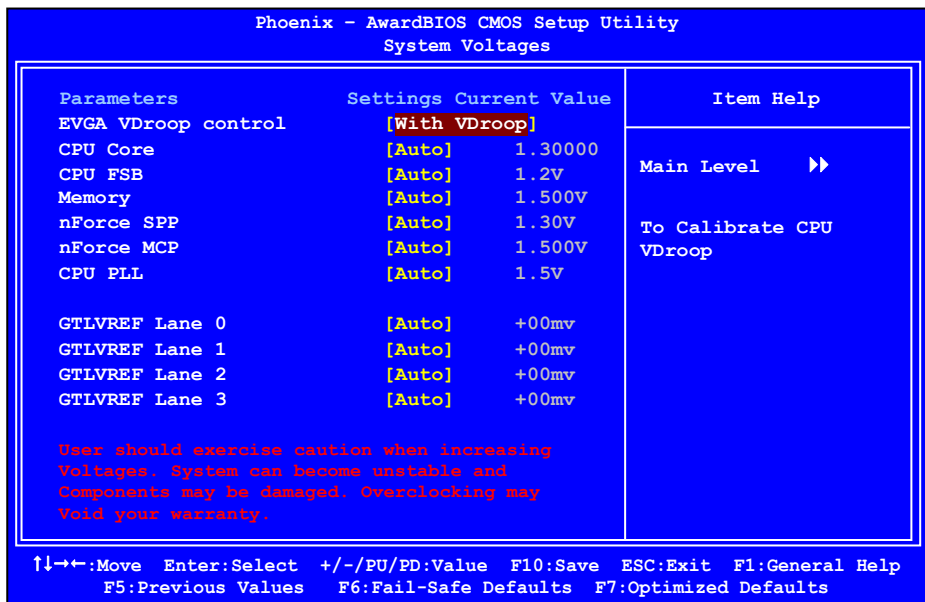

Figure 17. System Voltages Menu

- ❑ **EVGA VDroop control**
EVGA VDroop control is a safety measure by motherboards to protect the cpu. Select to **[With VDroop]** to calibrate CPU VDroop or select to **[Without VDroop]** to disable this function.
- ❑ **CPU Core**
Use the **Page Up** and **Page Down** keys to scroll through the voltages or select **[Auto]** to automatically set the voltage level for the CPU Core.

- ❑ **CPU FSB**
Use the **Page Up** and **Page Down** keys to scroll through the voltages or select **[Auto]** to automatically set the voltage level for the CPU FSB.
- ❑ **Memory**
This function defines the voltage level for the DRAM. Use the **Page Up** and **Page Down** keys to select a voltage or select **[Auto]** to automatically set the voltage.
- ❑ **nForce SPP**
This function defines the core voltage level for the NVIDIA nForce SPP chip. Use the **Page Up** and **Page Down** keys to select a voltage or select **[Auto]** to automatically set the voltage.
- ❑ **nForce MCP**
This function defines the core voltage level for the NVIDIA nForce MCP chip. Use the **Page Up** and **Page Down** keys to select a voltage or select **[Auto]** to automatically set the voltage.
- ❑ **CPU PLL**
This function defines the voltage level for the CPU PLL. Use the **Page Up** and **Page Down** keys to select a voltage (1.5V, 1.6V, 1.7V, 1.8V) or select **[Auto]** to automatically set the voltage.
- ❑ **GTLVREF Lane 0**
This function defines the voltage level for GTLVREF Lane 0. Use the **Page Up** and **Page Down** keys to select a voltage or select **[Auto]** to automatically set the voltage.
- ❑ **GTLVREF Lane 1**
This function defines the voltage level for GTLVREF Lane 1. Use the **Page Up** and **Page Down** keys to select a voltage or select **[Auto]** to automatically set the voltage.
- ❑ **GTLVREF Lane 2**
This function defines the voltage level for GTLVREF Lane 2. Use the **Page Up** and **Page Down** keys to select a voltage or select **[Auto]** to automatically set the voltage.
- ❑ **GTLVREF Lane 3**
This function defines the voltage level for GTLVREF Lane 3. Use the **Page Up** and **Page Down** keys to select a voltage or select **[Auto]** to automatically set the voltage.

Load Timing/Voltage Set

This function loads the system voltages and timing settings that were defined in the System Voltages menu. You can set up to three profile settings using the **Save timing/voltage set** function.

There are three profile options that can be loaded. The default setting is **Auto** for all settings. Press **Enter** to see the options.

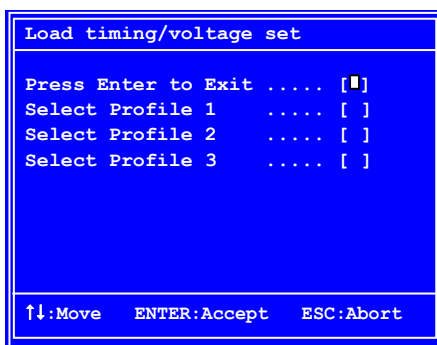

Save Timing/Voltage Set

This function saves the system voltages and timing settings that were defined in the System Voltages menu. There are three profile options that can be loaded. The default setting is **Auto** for all settings. Press **Enter** to see the options.

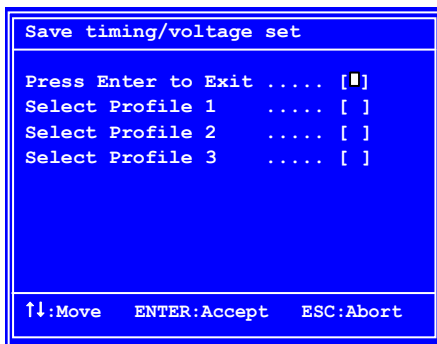

Installing Drivers and Software

It is important to remember that *before* installing the driver CD that is shipped in the kit, you need to load your operating system. The motherboard supports Windows XP 32bit and 64bit and is Vista-capable.

The CD that has been shipped with your EVGA motherboard contains the following software and drivers:

- ❑ Motherboard Drivers
- ❑ Audio Drivers
- ❑ SATA Controller Drivers
- ❑ Create a RAID Floppy Disk
- ❑ Adobe Acrobat Reader®
- ❑ View CD Manual

Windows XP Drivers Install

1. Insert the EVGA nForce 790i SLI FTW installation CD in the the system's CD-ROM Drive.
2. The CD will autorun, install the drivers and utilities listed on the install screen.

If the CD does not run, go to My Computer and click on the CD to open.

EVGA Glossary of Terms:

ACPI - Advanced Configuration and Power Interface

AFR – Alternate Frame Rendering

APIC - Advanced Programmable Interrupt Controller

BIOS - Basic Input Output System

CD-ROM - Compact Disc Read-Only Memory

CMOS - Complementary Metal-Oxide Semiconductor

CPU – Central Processing Unit

D-ICE – Dry Ice Cooling

DDR2 - Double Data Rate 2

DDR3 - Double Data Rate 3

DIMM - Dual In-line Memory Module

DRAM - Dynamic random access memory

DVD - Digital Versatile Disc

DVI – Digital Video Interface

FDC - Floppy Disk Controller

FSB – Front Side Bus

FTW – For The Win!

GHz – Gigahertz

GPU – Graphics Processing Unit

HDD - Hard Disk Drive

HDMI - High-Definition Multimedia Interface

HDR – High Dynamic Range Lighting

HPET - High Precision Event Timer

HSF - Heat Sink Fan

I/O - Input/Output

IDE - Integrated Drive Electronics

IEEE - Institute of Electrical and Electronics Engineers

IGP - Integrated Graphics Processors

IRQ - Interrupt Request

JBOD - Just a Bunch of Disks

JEDEC - Joint Electron Device Engineering Council

LAN - Local Area Network

LCD - Liquid Crystal Display

LGA – Land Grid Array
LN2 – Liquid Nitrogen Cooling
MAC - Media Access Control
MCP - Media and Communications Processor
MHz - Megahertz
NB - Northbridge
NCQ - Native Command Queuing
NIC - Network Interface Card
NTFS - New Technology File System
OEM - Original Equipment Manufacturer
PATA - Parallel Advanced Technology Attachment
PCB - Printed Circuit Board
PCI - Peripheral Component Interconnect
PCIe - Peripheral Component Interconnect Express
PCI-x - Peripheral Component Interconnect Extended
POST – Power on Self Test
QDR - Quad Data Rate
RAID - Redundant Array of Inexpensive Disks
RGB - Red Green Blue
SATA - Serial Advanced Technology Attachment
SB - Southbridge
SCSI - Small Computer System Interface
SFR – Split Frame Rendering
SLI - Scalable Link Interface
SPD - Serial Presence Detect
SPDIF - Sony/Philips Digital Interconnect Format
SPP - System Platform Processors
TCP/IP - Transmission Control Protocol/Internet Protocol
USB - Universal Serial Bus
VDroop - V-core Voltage Drop
VGA - Video Graphics Array

Appendix A. POST Codes for the EVGA nForce 790i SLI FTW Motherboard

This section provides the Award POST Codes (Table 6) for the EVGA nForce 790i SLI FTW Motherboard during system boot up.

These POST Codes are displayed on the LED POST Code readout located directly onboard the motherboard. Only (Table 6) Codes will display on the LED POST Code readout.



Debug LED

Table 6. Award POST Code

Award POST Codes		
Code	Name	Description
01	Reserved	
02	Jumps to E000 segment	Execution of POST routines in E000
03	Early Super IO	Init Early Initialized the super IO
04	Reserved	
05	Blank video	Reset Video controller
06	Reserved	
07	Init KBC	Keyboard controller init
08	KB test	Test the Keyboard
09	Reserved	
0A	Mouse Init	Initialized the mouse
0B	Reserved	

Award POST Codes		
Code	Name	Description
0C	Reserved	
0D	Reserved	
0E	Checksum Check	Check the integrity of the ROM, BIOS and message
0F	Reserved	
10	Autodetect EEPROM	Check Flash type and copy flash write/erase routines
11	Reserved	
12	Test CMOS	Test and Reset CMOS
13	Reserved	
14	Load Chipset	Load Chipset Defaults
15	Reserved	
16	Init Clock	Initialize onboard clock generator
17	Reserved	
18	Init CPU	CPU ID and initialize L1/L2 cache
19	Reserved	
1A	Reserved	
1B	Setup Interrupt Vector Table	Initialize first 120 interrupt vectors with SPURIOUS_INT_HDLR and initialize INT 00h-1Fh according to INT_TBL
1C	CMOS Battery Check	Test CMOS and check Battery Fail
1D	Early PM	Early PM initialization
1E	Reserved	
1F	Re-initial KB	Load keyboard matrix
20	Reserved	
21	HPM init	Init Heuristic Power Management (HPM)
22	Reserved	
23	Program chipset	Early Programming of chipset registers
24	Init PNP	Init PNP
25	Shadow VBIOS	Shadow system/video BIOS

Award POST Codes		
Code	Name	Description
26	Clock Gen	Init onboard clock generator and sensor
27	Setup BDA	Setup BIOS DATA AREA (BDA)
28	Reserved	
29	CPU Speed detect	Chipset programming and CPU Speed detect
2A	Reserved	
2B	Init video	Initialize Video
2C	Reserved	
2D	Video memory test	Test Video Memory and display Logos
2E	Reserved	
2F	Reserved	
30	Reserved	
31	Reserved	
32	Reserved	
33	Early keyboard reset	Early Keyboard Reset
34	Reserved	
35	Test DMA Controller 0	Test DMA channel 0
36	Reserved	
37	Test DMA Controller 1	Test DMA channel 1
38	Reserved	
39	Test DMA Page Registers	Test DMA Page Registers
3A	Reserved	
3B	Reserved	
3C	Test Timer	Test 8254 Timer 0 Counter 2.
3D	Reserved	
3E	Test 8259-1 Mask	Verify 8259 Channel 1 masked interrupts by alternately turning off and on the interrupt lines.
3F	Reserved	
40	Test 8259-2	Verify 8259 Channel 2 masked interrupts by

Award POST Codes		
Code	Name	Description
	Mask	alternately turning off and on the interrupt lines.
41	Reserved	
42	Reserved	
43	Test Stuck Interrupt	Turn off interrupts then verify no 8259's interrupt mask register is on. Test 8259 Force an interrupt and verify the interrupt occurred.
44	Reserved	
45	Reinit serial port	Reinitialize Preboot agent serial port
46	Reserved	
47	EISA Test	If EISA non-volatile memory checksum is good, execute EISA initialization. If not, execute ISA tests and clear EISA mode flag.
48	Reserved	
49	Size Memory	Size base memory from 256K to 640K and extended memory above 1MB.
4A	Reserved	
4B	Reserved	
4C	Reserved	
4D	Reserved	
4E	Init APIC	Initialize APIC and set MTRR
4F	Reserved	
50	USB init	Initialize USB controller
51	Reserved	
52	Memory Test	Test all memory of memory above 1MB using Virtual 8086 mode, page mode and clear the memory
53	Reserved	
54	Reserved	
55	CPU display	Detect CPU speed and display CPU vendor specific version string and turn on all necessary CPU features
56	Reserved	
57	PnP Init Display	PnP logo and PnP early init

Award POST Codes		
Code	Name	Description
58	Reserved	
59	Setup Virus	Setup virus protect according to Protect Setup
5A	Reserved	
5B	Awdflash Load	If required, will auto load Awdflash.exe in POST
5C	Reserved	
5D	Onboard I/O	Init Initializing onboard superIO
5E	Reserved	
5F	Reserved	
60	Setup enable	Display setup message and enable setup functions
61	Reserved	
62	Reserved	
63	Initialize Mouse	Detect if mouse is present, initialize mouse, install interrupt vectors.
64	Reserved	
65	PS2 Mouse special	Special treatment to PS2 Mouse port
66	Reserved	
67	ACPI init	ACPI sub-system initializing
68	Reserved	
69	Init Cache	Initialize cache controller
6A	Reserved	
6B	Setup	Enter setup check and autoconfiguration check up
6C	Reserved	
6D	Initialize Floppy	Initialize floppy disk drive
6E	Reserved	
6F	FDD install	Install FDD and setup BIOS data area parameters
70	Reserved	
71	Reserved	
72	Reserved	
73	Initialize Hard Drive	Initialize hard drive controller
74	Reserved	

Award POST Codes		
Code	Name	Description
75	Detect HDD	IDE device detection
76	Reserved	
77	Detect serial ports	Initialize serial ports.
78	Reserved	
79	Reserved	
7A	Detect parallel ports	Initialize parallel ports.
7B	Reserved	
7C	HDD Write Protect	HDD check for write protection
7D	Reserved	
7E	Reserved	
7F	POST error check	Check POST error and display them and ask for user intervention
80	Reserved	
81	Reserved	
82	Security Check	Ask password security.
83	Write CMOS	Write all CMOS values back to RAM and clear screen.
84	Display PNP	Display PNP devices
85	USB Final Init	Final USB initialization
86	Reserved	
87	Reserved	
88	Reserved	
89	Setup ACPI tables	Setup ACPI tables
8A	Reserved	
8B	Option ROM Detect	Scan for Option ROMs
8C	Reserved	
8D	Enable Parity Check	Enable Parity Check

Award POST Codes		
Code	Name	Description
8E	Reserved	
8F	IRQ12 Enable	Enable IRQ12 if mouse present
90	Reserved	
91	Reserved	
92	Reserved	
93	Boot Medium Read	Detect and store boot partition head and cylinders values in RAM
94	Final Init	Final init for last micro details before boot
95	NumLock	Set NumLock status according to Setup
96	Boot Attempt	Set low stack Boot via INT 19h.
C0	Base CPU test	Read/Write CPU registers
C1	Memory Presence	Base memory detect
C2	Early Memory	Board Initialization
C3	Extend Memory	Turn on extended memory, cache initialization
C4	Special Display	First display initialization
C5	Early Shadow	Early shadow enable for fast boot
C6	Cache presence	External cache size detection
CF	CMOS Check	CMOS checkup
B0	Spurious	If interrupt occurs in protected mode.
B1	Unclaimed NMI	If unmasked NMI occurs, display Press F1 to disable NMI, F2 reboot.
BF	Program MCP	To program chipset from defaults values
E1-EF	Setup Pages	E1- Page 1, E2 - Page 2, etc.
FF	Boot	