

User Guide

**EVGA force 780i SLI FTW  
Motherboard**

---



# Table of Contents

Before You Begin .....	ix
Parts NOT in the Kit .....	ix
Intentions of the Kit.....	ix
EVGA nForce 780i SLI FTW Motherboard .....	1
Motherboard Specifications .....	1
Unpacking and Parts Descriptions .....	3
Unpacking .....	3
Equipment .....	3
EVGA nForce 780i SLI FTW Motherboard .....	4
Hardware Installation .....	7
Safety Instructions.....	7
Preparing the Motherboard.....	8
Installing the CPU .....	8
Installing the CPU Fan .....	8
Installing Memory DIMMs .....	9
Installing the Motherboard .....	10
Installing the I/O Shield .....	10
Securing the Motherboard into the Chassis .....	10
Connecting Cables and Setting Switches .....	11
Power Connections.....	11
24-pin ATX Power (PWR1) .....	12
8-pin ATX 12V Power (PWR2) .....	14
Connecting IDE Hard Disk Drives .....	14
Connecting Serial ATA Cables.....	15
Connecting Internal Headers .....	16
Front Panel Header .....	16
IEEE 1394a .....	17
USB Headers .....	18

Audio .....	19
Fan Connections .....	20
COM1 .....	21
FDD Connector .....	22
Expansion Slots .....	22
PCI Slots .....	22
PCI Express x1 Slot .....	23
PCI Express x16 Slots .....	23
Clear CMOS Button .....	24
Configuring the BIOS .....	25
Enter BIOS Setup .....	26
Main Menu .....	26
Standard CMOS Features Menu .....	28
Date and Time .....	29
IDE Channel and SATA Channel .....	30
Drive A .....	31
Halt On .....	32
Memory .....	32
Advanced BIOS Features .....	33
Removable Device Priority .....	34
Hard Disk Boot Priority .....	34
Network Boot Priority .....	34
CPU Internal Cache .....	34
Quick Power On Self Test .....	34
First/Second/Third Boot Device .....	35
Boot Other Device .....	35
Boot Up NumLock Status .....	35
Security Option .....	35
APIC Mode .....	35
MPS Version Control For OS .....	36
Full Screen LOGO Show .....	36
Advanced Chipset Features .....	37

System BIOS Cacheable .....	37
HPET Function .....	37
Integrated Peripherals Menu .....	38
IDE Function Setup .....	39
RAID Config .....	40
USB Config .....	40
MAC Config .....	41
IEEE1394 controller .....	41
HD Audio .....	41
IDE HDD Block Mode .....	41
Onboard FDC Controller .....	41
Onboard Serial Port 1 .....	41
Power Management Setup Menu .....	42
ACPI Function .....	42
ACPI Suspend Type .....	42
Soft-Off by PBNT .....	43
WOL(PME#) From Soft-Off .....	43
Power On by Alarm .....	43
POWER ON Function .....	44
PnP/PCI Configuration Menu .....	45
Init Display First .....	45
Reset Configuration Data .....	45
Resources Controlled By .....	46
IRQ Resources .....	46
PCI/VGA Palette Snoop .....	46
Maximum Payload Size .....	47

PC Health Status .....	47
Dynamic Fan Control .....	48
Frequency/Voltage Control .....	49
Dummy O.C. ....	49
System Clocks.....	50
Frequency Settings .....	51
HT Multiplier .....	51
Spread Spectrum .....	52
FSB & Memory Config .....	53
SLI Ready Memory .....	53
FSB & Memory clock mode .....	54
FSB (QDR), MHz.....	54
MEM (DDR), MHz .....	54
Memory Timing Settings.....	55
Optimal .....	55
Expert .....	56
CPU Feature .....	57
Limit CPUID MaxVal.....	57
Intel SpedStep .....	57
PPM Mode .....	57
CPU Thermal Control .....	58
C1E Enhanced Halt State .....	58
Execute Disable Bit .....	58
Virtualization Technology .....	58
CPU Core 1-3 .....	58

System Voltage .....	59
EVGA VDroop Control .....	59
CPU Core .....	59
CPU FSB .....	59
Memory .....	59
nForce SPP .....	59
nForce MCP .....	60
HT nForce SPP <-> MCP .....	60
nForce MCP Auxiliary .....	60
GTLVREF Lane 0-2 .....	60
GTLVREF Lane 3 .....	60
NVMM Memory Test .....	60
Load Timing/Voltage Set .....	61
Save Timing/Voltage Set .....	61
Installing Drivers and Software .....	63
Driver Installation.....	63
EVGA Enthusiast Glossary.....	65
Appendix A. POST Codes for EVGA nForce 780i SLI FTW Platform.....	67
NVMM POST Codes .....	73

# List of Figures

Figure 1.	EVGA nForce 780i SLI FTW Motherboard Layout.....	5
Figure 2.	Chassis Back Panel Connectors .....	6
Figure 3.	Power Supply Connectors .....	12
Figure 4.	PWR1 Motherboard Connector .....	13
Figure 5.	BIOS CMOS Setup Utility Main Menu.....	27
Figure 6.	Standard CMOS Features Menu .....	29
Figure 7.	Advanced BIOS Features Menu .....	33
Figure 8.	Advanced Chipset Features .....	37
Figure 9.	Integrated Peripherals Menu .....	38
Figure 10.	Power Management Setup Menu .....	42
Figure 11.	PnP/PCI Configuration Menu.....	45
Figure 12.	PC Health Status .....	47
Figure 13.	System Clocks Menu.....	50
Figure 14.	FSB & Memory Config Menu .....	53
Figure 15.	CPU Configuration Menu.....	57
Figure 16.	System Voltages Menu.....	59



# Before You Begin...

---

## Parts NOT in the Kit

This kit contains all the hardware necessary to install and connect your new EVGA force® 780i SLI FTW motherboard. However, it does not contain the following items that must be purchased separately to make the motherboard functional.

- ❑ Intel microprocessor
- ❑ System Memory
- ❑ Cooling fan for the microprocessor
- ❑ Graphics Card
- ❑ Power Supply

EVGA assumes you have purchased all necessary parts needed to allow for proper system functionality.

---

## Intentions of the Kit

This kit provides you with the motherboard and all connecting cables necessary to install the motherboard into a PC case. If you are *building* a PC, you will use most of the cables provided in the kit. If however, you are *replacing* a motherboard, you will not need many of the cables.

When *replacing* a motherboard in a PC case, it is highly recommended to reinstall the operating system even though the current drives may already have an operating system.



# EVGA nForce 780i SLI FTW Motherboard

Thank you for buying the EVGA nFore 780i SLI FTW Motherboard: This motherboard offers the tools and performance PC users' demand. When combined with two or three SLI-Ready NVIDIA GeForce graphics cards, you get innovative NVIDIA SLI Technology for enhanced system performance.

---

## Motherboard Specifications

- ❑ Size
  - ATX form factor of 12 inch x 9.6 inch
- ❑ Microprocessor support
  - Intel Core 2 Extreme, Intel Core 2 Quad, Intel Core 2 Duo, Pentium EE, Pentium D, Pentium
- ❑ Operating systems:
  - Supports Windows XP 32bit/64bit and Windows Vista 32bit/64bit
- ❑ Contains NVIDIA nForce 780i SLI MCP and SPP
- ❑ System Memory support
  - Supports dual channel JEDEC DDR2-800 and SLI-Ready memory up to 1200 MHz.
  - Supports up to 8 GBs of DDR2 memory.
- ❑ Ten USB 2.0 Ports
  - Supports hot plug
  - Ten USB 2.0 ports (six rear panel ports, four onboard USB headers)
  - Supports wake-up from S1 and S3 mode
  - Supports USB 2.0 protocol up to 480 Mbps transmission rate
- ❑ Onboard Serial ATA II
  - 300MBps data transfer rate
  - Six Serial ATA II connectors
  - NVIDIA Media Shield RAID with support for RAID 0, RAID 1, RAID 0+1, RAID 5, and JBOD
  - Supports hot plug and NCQ (Native Command Queuing)

- ❑ Onboard LAN
  - Dual LAN interface built-in onboard
  - Supports 10/100/1000 Mbit/sec Ethernet
- ❑ Onboard 1394
  - Supports hot plug
  - Two 1394a ports (one rear panel port, one onboard header) with a rate transmission of 400 Mbps
- ❑ Onboard Audio
  - Azalia High-Definition audio
  - Supports 8-channel audio
  - Supports S/PDIF output
  - Supports Jack-Sensing function
- ❑ Triple PCI Express x16 Support
  - 2 x16 PCI Express 2.0
  - 1 x16 PCI Express 1.0
  - Supports 4 GB/sec (8 GB/sec concurrent) bandwidth
  - Low power consumption and power management features
- ❑ Green Function
  - Supports ACPI (Advanced Configuration and Power Interface)
  - Supports S0 (normal), S1 (power on suspend), S3 (suspend to RAM), S4 (Suspend to disk - depends on OS), and S5 (soft - off)
- ❑ Expansion Slots
  - Two PCI slots
  - One PCI Express x1 slot
  - Three PCI Express x16 Graphics slots

# Unpacking and Parts Descriptions

---

## Unpacking

The EVGA nForce 780i SLI FTW motherboard comes with all the necessary cables for adding a motherboard to a new chassis. If you are replacing a motherboard, you may not need many of these cables.

Be sure to inspect each piece of equipment shipped in the packing box. If anything is missing or damaged, contact your reseller.

All parts shipped in this kit are RoHS-compliant (lead-free) parts.

---

## Equipment

The following equipment is included in the EVGA nForce 780i SLI FTW motherboard box. (Accessories may vary between models, see product package)



---

**EVGA nForce 780i SLI FTW Motherboard**  
This PCI Express motherboard contains the NVIDIA nForce 780i SLI SPP and MCP and is SLI-ready.



---

**I/O Shield**  
Installs in the chassis to block radio frequency transmissions, protect internet components from dust and foreign objects and aids in proper airflow within the chassis.



---

**Floppy Cable**  
Used to attach a floppy drive to the motherboard.

---



**2-Port SATA Power Cable (Qty Three)**  
Allows a Molex power connector to adapt to a SATA power connector



**1394 Cable**  
Provides two additional 1394 ports to either the front or back panels of the chassis.



**USB 2.0 4-Port Cable**  
Provides four additional USB ports to either the front or back panels of the chassis.



**SATA Signal Cable (Qty Six)**  
Used to support the Serial ATA protocol and each one connects a single drive to the motherboard



**Serial Port Bracket Cable**  
Used for serial legacy devices



**IDE-ATA 133 HDD Cable**  
Passes data between the IDE connection on both the Motherboard and IDE device

---

---

## EVGA nForce 780i SLI FTW Motherboard

The EVGA nForce 780i SLI FTW motherboard with the NVIDIA nForce 780i SLI SPP and MCP processor is a PCI Express, SLI-ready motherboard. Figure 1 shows the motherboard and Figures 2 shows the back panel connectors.

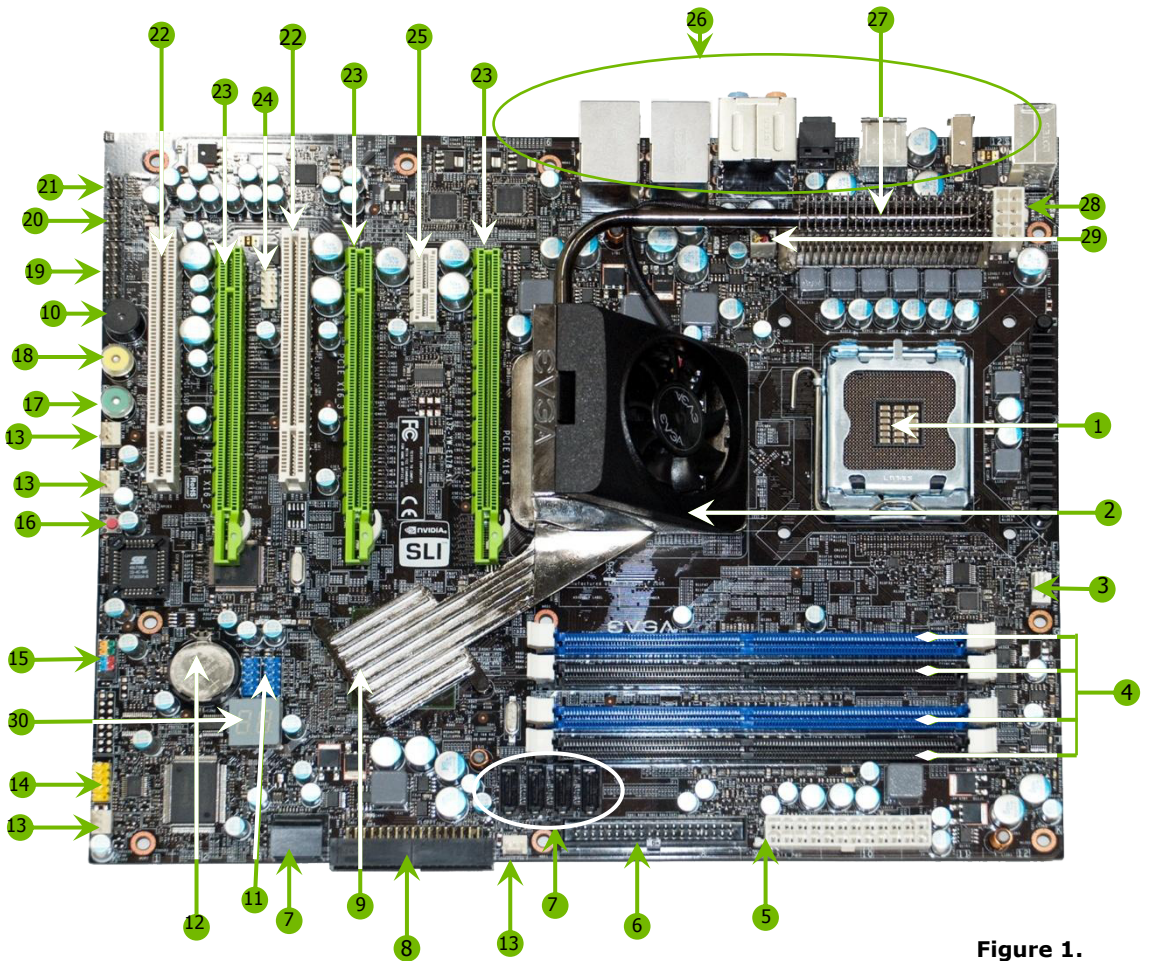

**Figure 1.**  
EVGA nForce 780i SLI FTW Motherboard Layout

1. CPU Socket – For use with Intel LGA 775 CPUs	11. USB headers – for additional USB connectors.	21. SPDIF connector – Digital Audio connection
2. NVIDIA SPP with Active fan – Also known as the Northbridge	12. Motherboard battery – helps retain system BIOS settings	22. PCI slots – Used for PCI based components
3. CPU fan connector – Connect CPU Fan to this connector.	13. Fan connector	23. PCI Express x16 slots (SLI) – For graphics cards, multiple slots are used for SLI configurations
4. DDR DIMM Slots 0 – 3 – For System Memory	14. Serial connector – for Serial Port dongal	24. 1394a connector – Firewire connection
5. 24-pin ATX Power Connector – Main Power connection	15. Front panel connector – For use with system chassis	25. PCI Express x1 slot – Exclusive for devices that require a PCI-E x1 slot
6. IDE Connector – For IDE devices, CD-ROM and Hard Disk Drives	16. CMOS Clear – Easily clears the system the BIOS.	26. Back panel connectors – See Figure 2
7. Serial-ATA (SATA) connectors – For SATA devices, CD-ROM and Hard Disk Drives	17. Power button – with integrated power LED indicator	27. PWM / Voltage Regulator Heatsink – Aids in dispersing heat
8. FDD connector – Floppy Disk Drive Connector	18. Reset Button – With integrated HDD activity light.	28. 8-pin ATX 12V power connector – CPU 8-Pin Power connector
9. NVIDIA MCP (passive heat sink)	19. Azalia HD Audio Header	29. MCP/ SPP fan connector
10. System Speaker – Provides POST Codes via audio	20. Front Panel Audio – For use with system chassis	30. LED POST Code Readout – See Appendix A. For Code descriptions

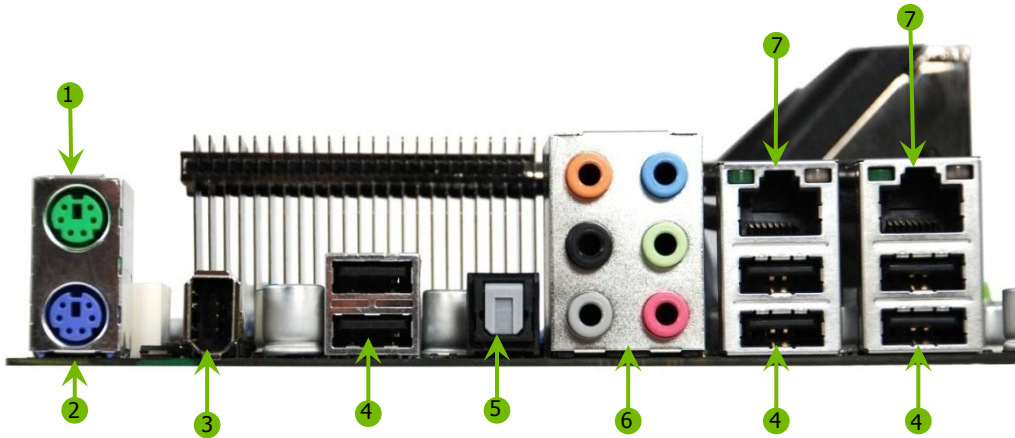

Figure 2. Chassis Back Panel Connectors

1. PS/2 Mouse Port
2. PS/2 Keyboard Port
3. 1394a (Firewire) Port
4. USB 2.0 ports (SIX)
5. SPDIF output

6. Port	2-Channel	4-Channel	6-Channel/8-Channel
Blue	Line-In	Line-In	Line-In
Green	Line-Out	Front Speaker Out	Front Speaker Out
Pink	Mic In	Mic In	Mic In
Orange			Center/Subwoofer
Black		Rear Speaker Out	Rear Speaker Out
Grey			

7. LAN Port with LEDs to indicate status.
  - Yellow/Light Up/Blink = 10 Mbps/Link/Activity
  - Yellow and Green/Light Up/Blink = 100 Mbps/link/Activity
  - Green/Light Up/Blink = 1000 Mbps/Link/Activity



# Hardware Installation

This section will guide you through the installation of the motherboard. The topics covered in this section are:

- ❑ Preparing the motherboard
  - Installing the CPU
  - Installing the CPU fan
  - Installing the memory
- ❑ Installing the motherboard
- ❑ Connecting cables and setting switches

---

## Safety Instructions

**To reduce the risk of fire, electric shock, and injury always follow basic safety precautions.**

**Remember to remove power from your computer by disconnecting the AC main source before removing or installing any equipment from/to the computer chassis.**

---

# Preparing the Motherboard

## Installing the CPU

Be very careful when handling the CPU. Make sure not to bend or break any pins on the back. Hold the processor only by the edges and do not touch the bottom of the processor.

Use the following procedure to install the CPU onto the motherboard.

1. Unhook the socket lever by pushing *down* and *away* from the socket.
2. Lift the load plate. There is a protective socket cover on the load plate to protect the socket when there is no CPU installed.
3. Remove the protective socket cover from the load plate.
4. Remove the processor from its protective cover, making sure you hold it only by the edges.  
It is a good idea to save the cover so that whenever you remove the CPU, you have a safe place to store it.
5. Align the notches in the processor with the notches on the socket.
6. Lower the processor straight down into the socket with out tilting or sliding it into the socket

---

**Make sure the CPU is fully seated and level in the socket.**

---

7. Close the load plate over the CPU and press down while you close and engage the socket lever.

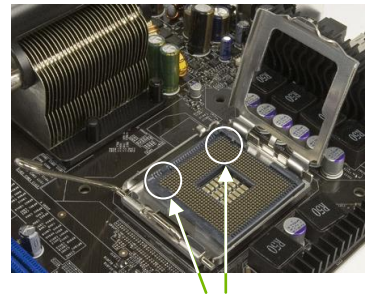
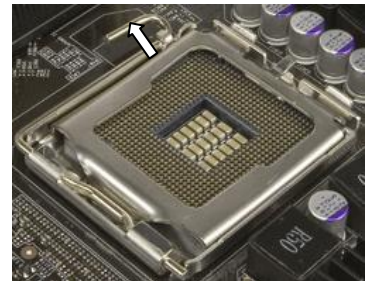

Align notches with notches on the CPU



## Installing the CPU Fan

There are many different fan types that can be used with this motherboard. Follow the instructions that came with your fan assembly. Be sure that the fan orientation is correct for your chassis type and your fan assembly.

## Installing System Memory (DIMMs)

Your new motherboard has four 1.8V 240-pin slots for DDR2 memory. These slots support 256 MB, 512 MB, 1 GB, and 2 GB DDR2 memory modules. They also support dual channel DDR2 memory technology up to 10.7GB/s. There must be at least one memory bank populated to ensure normal operation. Use the following the recommendations for installing memory. (See Figure 1 on page 5 for the location of the memory slots.)

- ❑ **One DIMM:** Install into slot 0. You can install the DIMM into any slot however, slot 0 is preferred.
- ❑ **Two DIMMs:** Install into either slot 0 and 1 or 2 and 3. The idea is to not have the DIMMs in adjacent slots.
- ❑ **Four DIMMs:** Install into slots 0, 1, 2, and 3.

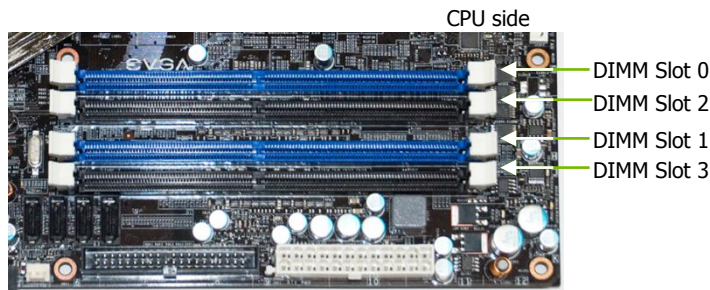

Use the following procedure to install memory DIMMs. Note that there is only one gap near the center of the DIMM slot. This slot matches the slot on the memory DIMM to ensure the component is installed properly.

1. Unlock a DIMM slot by pressing the module clips outward.
2. Align the memory module to the DIMM slot and insert the module vertically while applying light downward pressure to properly seat the DIMM. The plastic clips at both sides of the DIMM slot automatically lock the DIMM into the connector.

---

## Installing the Motherboard

The sequence of installing the motherboard into the chassis depends on the chassis you are using and if you are replacing an existing motherboard or working with an empty chassis. It is recommended to secure the motherboard first before making all connections.

Use the following procedure to install the I/O shield and secure the motherboard into the chassis.

Be sure that the CPU fan assembly has enough clearance for the chassis covers to lock into place and for the expansion cards. Also make sure the CPU Fan assembly is aligned with the vents on the covers.

## Installing the I/O Shield

The motherboard kit comes with an I/O shield that is used to block radio frequency transmissions, protects internal components from dust and foreign objects, and promotes correct airflow within the chassis.

Before installing the motherboard, install the I/O shield from the *inside* of the chassis. Press the I/O shield into place and make sure it fits securely. If the I/O shield does not fit into the chassis, you would need to obtain the proper size from the chassis supplier.

## Securing the Motherboard into the Chassis

Most computer chassis have a base with mounting studs or spacers to allow the mother board to be secured to the chassis and help to prevent short circuits. If there are studs that do not align with a mounting hole on the motherboard, it is recommended that you remove that stud to prevent the possibility of a short circuit. In most cases, it is recommended to secure the motherboard using a minimum of eight (8) to ten (10) spacers.

1. Carefully place the motherboard onto the studs/spacers located inside the chassis.
2. Align the mounting holes with the studs/spacers.
3. Align the connectors to the I/O shield.
4. Ensure that the fan assembly is aligned with the chassis vents according to the fan assembly instruction.
5. Secure the motherboard with a minimum of eight-to-ten screws.

---

## Connecting Cables and Setting Switches

This section takes you through all the connections and switch settings necessary on the motherboard. This will include:

- ❑ Power Connections
  - 24-pin ATX power (**PWR1**)
  - 8-pin ATX 12V power (**PWR2**)
- ❑ Internal Headers
  - Front panel
  - IEEE 1394a
  - USB Headers
  - Audio
  - Speaker
  - COM
- ❑ FDD
- ❑ IDE
- ❑ Serial ATA II
- ❑ Chassis Fans
- ❑ Rear panel USB 2.0 Adapter
- ❑ Expansion slots
- ❑ CMOS jumper settings

See Figure 1 on page 5 to locate the connectors and jumpers referenced in the following procedure.

## Power Connections

To support 3-way SLI, this motherboard has the following specific minimum power supply requirements:

- ❑ A Power Supply that features 1000 W peak power
- ❑ 6-pin and/or 8-pin PCI-E power connectors configured in either of the following configurations (see Figure 3):
  - Four 6-pin (3x2) and two 8-pin (4x2) PCI-E power connectors
  - Six 6-pin (3x2) PCI-E power connectors
  - Three 6-pin (3x) and three 8-pin (4x2) PCI-E power connectors



8-pin (4x2) PCI-E Connector

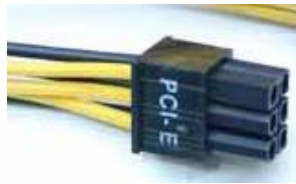

6-pin (3x2) PCI-E connector

**Figure 3. Power Supply Connectors**

Make sure you have enough power to cover all the expansion cards you will be installing. To determine what power requirements are for your specific configuration or a certified power supply vendor, refer to [www.slizone.com](http://www.slizone.com).

## 24-pin ATX Power (PWR1)

**PWR1** is the main power supply connector located along the edge of the board next to the DIMM slots. Make sure that the power supply cable and pins are properly aligned with the connector on the motherboard. Firmly plug the power supply cable into the connector and make sure it is secure. This connector is notched, do not force in.

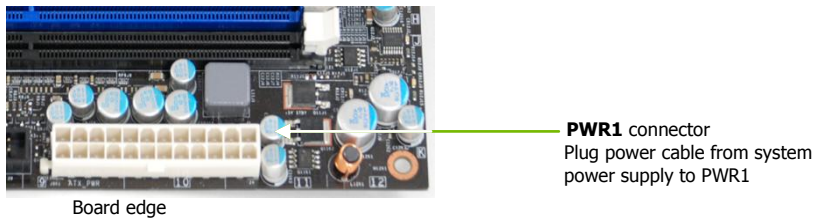

Figure 4. PWR1 Motherboard Connector

Table 1. PWR1 Pin Assignments

Connector	Pin	Signal	Pin	Signal
	1	+3.3V	13	+3.3V
	2	+3.3V	14	-12V
	3	GND	15	GND
	4	+5V	16	PS_ON
	5	GND	17	GND
	6	+5V	18	GND
	7	GND	19	GND
	8	PWROK	20	RSVD
	9	+5V_AUX	21	+5V
	10	+12V	22	+5V
	11	+12V	23	+5V
	12	+3.3V	24	GND

## 8-pin ATX 12V Power (PWR2)

**PWR2**, the 8-pin ATX 12V power connection, is used to provide power to the CPU. Align the pins to the connector and press firmly until seated. This connector is notched, do not force in.

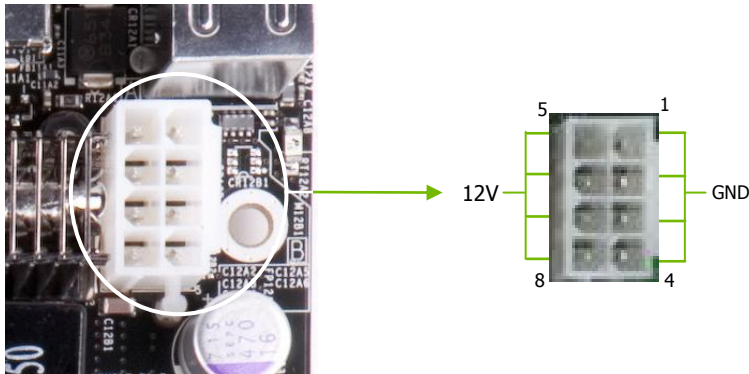

## Connecting IDE Hard Disk Drives

The IDE connector supports Ultra ATA 133/100/66 IDE hard disk drives.

1. Connect the blue connector (the cable end with a single connector) to the motherboard.
2. Connect the black connector (the cable with the two closely spaced black and gray connectors) to the Ultra ATA master device.
3. Connect the gray connector to a slave device.

If you install two hard disk drives, you must configure the second drive as a slave device by setting its jumper accordingly. Refer to the hard disk drive's documentation for the jumper settings.

If an ATA-66/100 disk drive and a disk drive using any other IDE transfer protocol are attached to the same cable, the maximum transfer rate between the drives may be reduced to that of the slowest drive.



# Connecting Serial ATA Cables

The Serial ATA II connector is used to connect the Serial ATA II device to the motherboard. These connectors support the thin Serial ATA II cables for primary storage devices. The current Serial ATA II interface allows up to 300MB/s data transfer rate.

There are six serial ATA connectors on the motherboard that support RAID 0, RAID 1, RAID 5, RAID 0+1 and JBOD configurations.

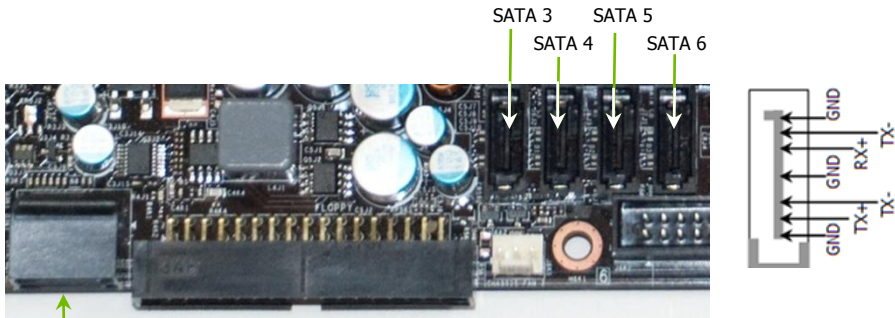

SATA 1 (bottom)  
SATA 2 (top)

Connect the locking cable end to the motherboard connector.  
Connect the end without the lock to the drive.



# Connecting Internal Headers

## Front Panel Header

The front panel header on this motherboard is one connector used to connect the following four cables:

(see Table 2 for pin definitions)

### ❑ PWRLED

Attach the front panel power LED cable to these two pins of the connector.

The Power LED indicates the system's status. When the system is in S0 status, the LED is on. When the system is in S1, S3, S4, S5 status, the LED is off.

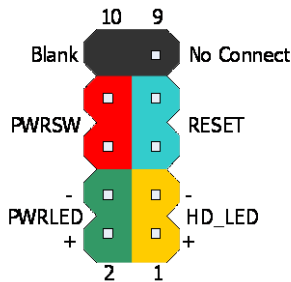

Some chassis do not have all four cables. Be sure to match the name on the connectors to the corresponding pins.

### ❑ PWRSW

Attach the power button cable from the case to these two pins. Pressing the power button on the front panel turns the system on and off rather than using the power supply button.

### ❑ HD\_LED

Attach the hard disk drive indicator LED cable to these two pins. The HDD indicator LED indicates the activity status of the hard disk drives.

### ❑ RESET

Attach the Reset switch cable from the front panel of the case to these two pins. The system restarts when the **RESET** switch is pressed.

Table 2. Front Panel Header Pins

	Pin	Signal	In/Out	Description
<b>HD_LED</b>	1	HD_PWR	Out	Hard disk drive LED pulls up to +5V
	3	HDA#	Out	Hard disk drive active LED
<b>PWRLED</b>	2	HDR_BLNK_GRN	Out	Front panel green light
	4	HDR_BLNK_YEL	Out	Front panel yellow light
<b>RESET</b>	5	GND		Ground
	7	FP_RESET#	In	Reset switch
<b>PWRSW</b>	6	SWITCH_ON#	In	Power switch
	8	GND		Ground
<b>No Connect</b>	9	No Connect		
<b>Empty</b>	10	Empty		

## IEEE 1394a

The IEEE 1394a expansion cable bracket is provided in the box but if you do not require the additional external connections, you do not need to install it.

1. Secure the bracket to either the front or rear panel of your chassis (not all chassis are equipped with the front panel option).
2. Connect the two ends of the cables to the IEEE 1394a connectors on the motherboard.

Table 3. IEEE 1394a Connector Pins

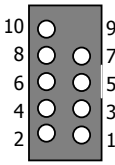
Connector	Pin	Signal
IEEE 1394a Connector  	1	TPA+
	2	TPA-
	3	GND
	4	GND
	5	TPB+
	6	TPB-
	7	+12V
	8	+12V
	9	Empty
	10	GND

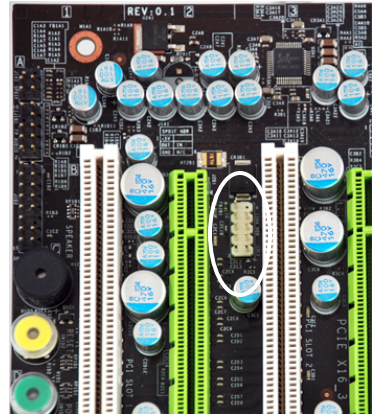

## USB Headers

This motherboard contains six (6) USB 2.0 ports that are exposed on the rear panel of the chassis (Figure 2). The motherboard also contains two 10-pin internal header connectors onboard that can be used to connect an optional external bracket containing four (4) more USB 2.0 ports.



1. Secure the bracket to either the front or rear panel of your chassis (not all chassis are equipped with the front panel option).
2. Connect the two ends of the cables to the USB 2.0 headers on the motherboard.

Table 4. USB 2.0 Header Pins

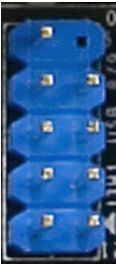
Connector	Pin	Signal	
	1	5V_DUAL	
	3	D-	
	5	D+	
	7	GND	
	9	Empty	
	Pin	Signal	
	2	5V_DUAL	
	4	D-	
	6	D+	
	8	GND	
10	No Connect		

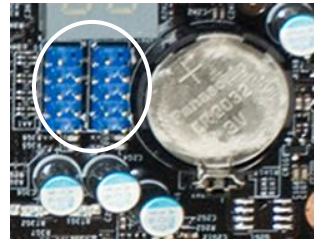

# Audio

The audio connector supports HD audio standard and provides two kinds of audio output choices: Front Audio and Rear Audio. The front Audio supports re-tasking function.

Table 5. Front Audio Connector

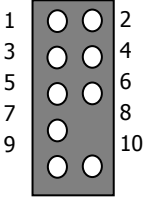
Connector	Pin	Signal
Front Audio Connector  	1	PORT1_L
	2	AUD_GND
	3	PORT1_R
	4	PRECENCE_J
	5	PORT2_R
	6	SENSE1_RETURN
	7	SENSE_SEND
	8	Empty
	9	PORT2_L
	10	SENSE2_RETURN



# Fan Connections

There are five fan connections on the motherboard. The fan speed can be detected and viewed in the **PC Health Status** section of the CMOS Setup. The fans are automatically turned off after the system enters S3, S4 and S5 mode.

Note that the CPU fan cable can be either a 3-pin or a 4-pin connector. Connect a 3-pin connector to pins 1, 2, and 3 on the motherboard connector.

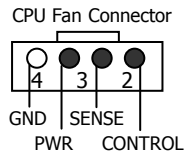

EVGA nForce 780i SLI SPP/MCP fan connector

Install the fan over the nForce 780i SLI SPP to draw heat from the MCP. The fan plugs into a 3-pin connector.

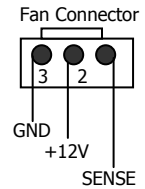

There are four more optional fan connectors on the motherboard that can be used for adding more system fans.

Auxiliary fan connector

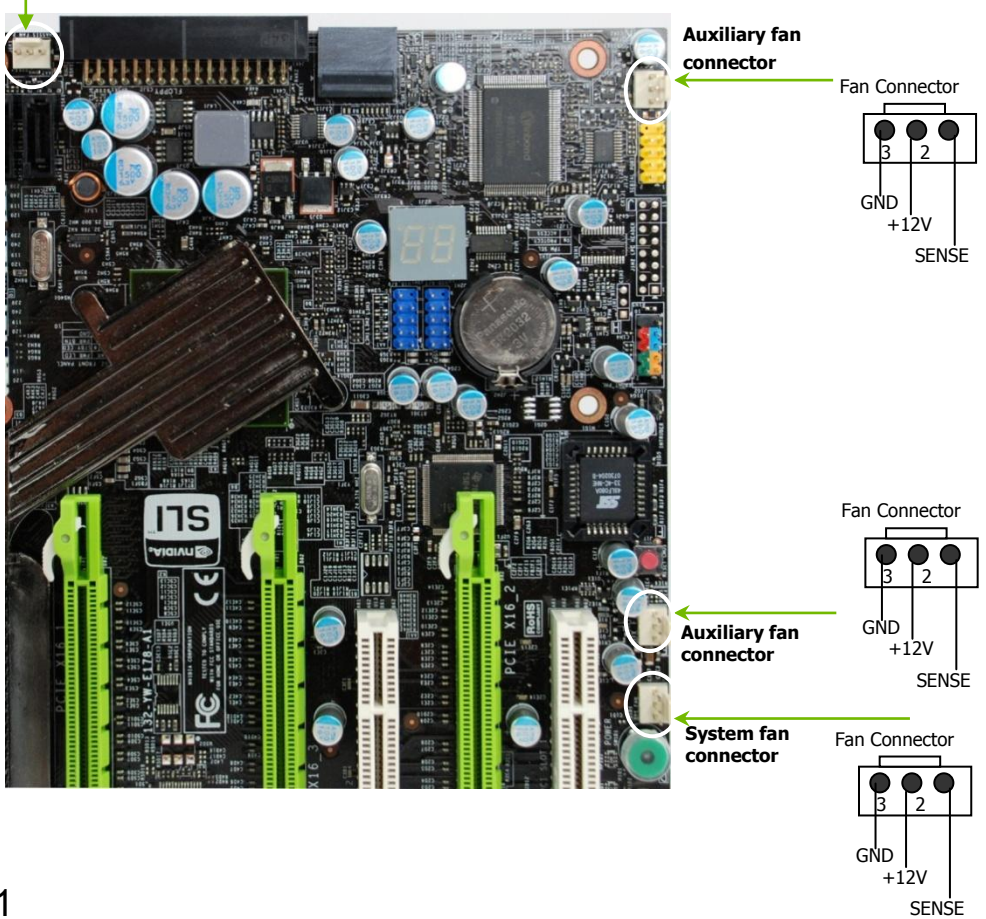

## COM1

The motherboard kit provides an additional serial COM header for your machine. Connect one side of a switching cable to the header and then attach the serial COM device to the other side of the cable.

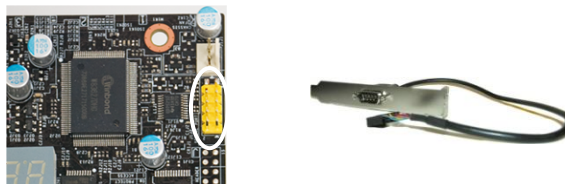

## Floppy Disk Drive (FDD) Connector

The motherboard supports a standard 360K, 720K, 1.2M, 1.44m, and a 2.88M floppy disk drive (FDD).



## Expansion Slots

The EVGA nForce 780i SLI FTW motherboard contains six expansion slots, four PCI Express slots and two PCI slots.

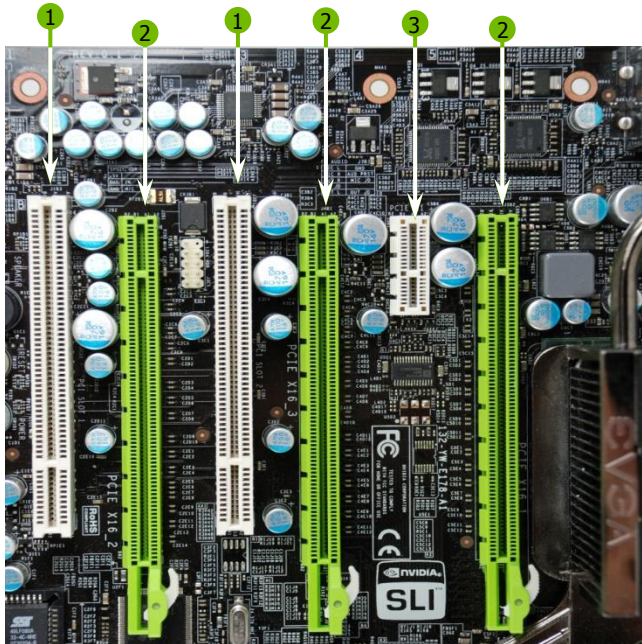

- 1 – PCI slots
- 2 – PCIe x16 slots (3-Way SLI)
- 3 – PCIe x1 slot

## PCI Slots

The two PCI slots support many expansion cards such as a LAN card, USB card, SCSI card and other cards that comply with PCI specifications. When installing a card into the PCI slot, be sure that it is fully seated. Secure the card's metal bracket to the chassis back panel with the screw used to hold the blank cover.



## PCI Express x1 Slot

There is one PCI Express x1 slot that is designed to accommodate less bandwidth-intensive cards, such as a modem, LAN card, or soundcard card. The x1 slot provides up to 250 MB/sec bandwidth.

## PCI Express x16 Slots

These three PCI Express x16 slots are reserved for graphics or video cards. The design of this motherboard supports three PCI-Express graphics cards using NVIDIA's SLI technology.

When installing a PCI Express x16 card, be sure the retention clip snaps and locks the card into place. If the card is not seated properly, it could cause a short across the pins. Secure the card's metal bracket to the chassis back panel with the screw used to hold the blank cover.

---

## Clear CMOS Function

The motherboard contains a button to clear BIOS configurations back to default settings. Please see Figure 1 on page 6 for location.

## Clear CMOS Button

The motherboard uses the CMOS to store all the set parameters. The CMOS can be cleared by pressing the Clear CMOS button on the motherboard.

Use the following procedure to clear CMOS:

1. Turn off the AC power supply
2. Press the clear CMOS button once to clear the CMOS.
3. Turn the AC power supply back on.

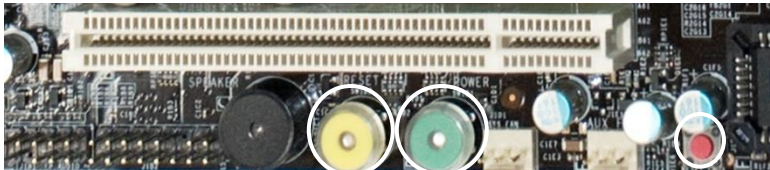

**Onboard  
Reset  
Button**

**Onboard  
Power  
Button**

**Onboard  
Clear  
CMOS  
Button**

## Onboard System Reset and Power Buttons

The motherboard provides an onboard Power and Reset button. The Yellow Reset button features an integrated Hard Disk Drive Activity LED which will flicker accordingly.

The Green Power button features an integrated power LED and will stay solid for as long as the system is turned on and running.

# Configuring the BIOS

This section discusses how to change the system settings through the BIOS Setup menus. Detailed descriptions of the BIOS parameters are also provided.

This section includes the following information:

- ❑ Enter BIOS Setup
- ❑ Main Menu
- ❑ Standard CMOS Features
- ❑ Advanced BIOS Features
- ❑ Advanced Chipset Features
- ❑ Integrated Peripherals
- ❑ Power Management Setup
- ❑ PnP/PCI Configurations
- ❑ PC Health Status
- ❑ Frequency/Voltage Control

---

## Enter BIOS Setup

The BIOS is the communication bridge between hardware and software. Correctly setting the BIOS parameters is critical when maintaining optimal system performance.

Use the following procedure to verify/change BIOS settings.

1. Power on the computer.
2. Press the **Del** key when the following message briefly displays at the bottom of the screen during the Power On Self Test (POST).

Press F1 to continue, DEL to enter Setup.

Pressing **Del** takes you to the Phoenix-Award BIOS CMOS Setup Utility.

---

It is *strongly* recommended that you do not change the default BIOS settings. Changing some settings could damage your computer.

---

---

## Main Menu

The main menu allows you to select from the list of setup functions and two exit choices. Use the **Page Up** and **Page Down** keys to scroll through the options or press **Enter** to display the associated submenu. Use the **↑↓** arrow keys to position the selector in the option you choose. To go back to the previous menu, press **Esc**.

---

Note that on the BIOS screens all data in **white** is for information only, data in **yellow** is changeable, data in **blue** is non-changeable, and data in a **red box** is highlighted for selection.

---

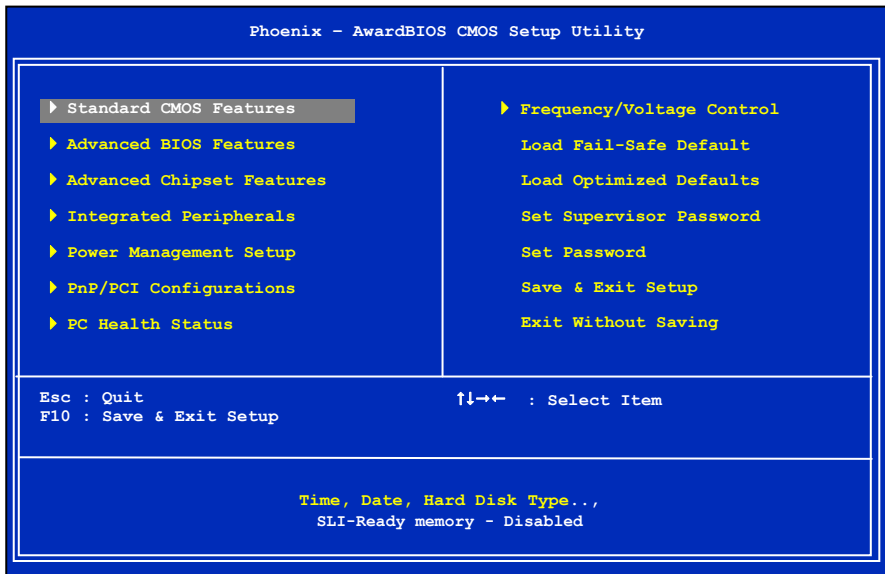

Figure 5. BIOS CMOS Setup Utility Main Menu

- Standard CMOS Features**  
Use this menu to set up the basic system configuration.
- Advanced BIOS Features**  
Use this menu to set up the advanced system features and boot sequence.
- Advanced Chipset Features**  
Use this menu to adjust system bios cacheable and HPET Functions.
- Integrated Peripherals**  
Use this menu to set up onboard peripherals such as IDE, RAID, USB, LAN, and MAC control.
- Power Management Setup**  
Use this menu to configure power management, power on, and sleep features.
- PnP/PCI Configurations**  
Use this menu to modify the system's Plug-and-Play and PCI configurations.
- PC Health Status**  
Use this menu to monitor the real-time system status of your PC, including temperature, voltages, and fan speed.
- Frequency/Voltage Control**  
Use this menu to optimize system performance and configure clocks, voltages, memory timings, and more.

The following items on the CMOS Setup Utility main menu are commands rather than submenus:

- ❑ **Load Fail Safe Defaults**  
Load default system settings.
- ❑ **Load Optimized Defaults**  
Loads optimized system settings.
- ❑ **Set Supervisor Password**  
Use this command to set, change, and disable the password used to access the BIOS menu.
- ❑ **Set User Password**  
Use this command to set, change, and disable the password used to access the BIOS menu.
- ❑ **Save & Exit Setup**  
Use this command to save settings to CMOS and exit setup.
- ❑ **Exit Without Saving**  
Use this command to abandon all setting changes and exit setup.

**SLI-Ready Memory** is a status indicator displayed at the bottom of the BIOS screen. The three status indicators are:

- ❑ **Enabled:** SLI-Ready memory is detected and enabled.
- ❑ **Disabled:** SLI-Ready memory is detected but disabled.
- ❑ **Not Detected:** SLI-Ready memory is not detected.

---

## Standard CMOS Features Menu

The Standard CMOS Features menu is used to configure the standard CMOS information, such as the date, time, HDD model, and so on. Use the **Page Up** and **Page Down** keys to scroll through the options or press **Enter** to display the sub-menu. Use the **↑↓** arrow keys to position the selector in the option you choose. To go back to the previous menu, press **Esc**.

The information shown in **Item Help** corresponds to the option highlighted.

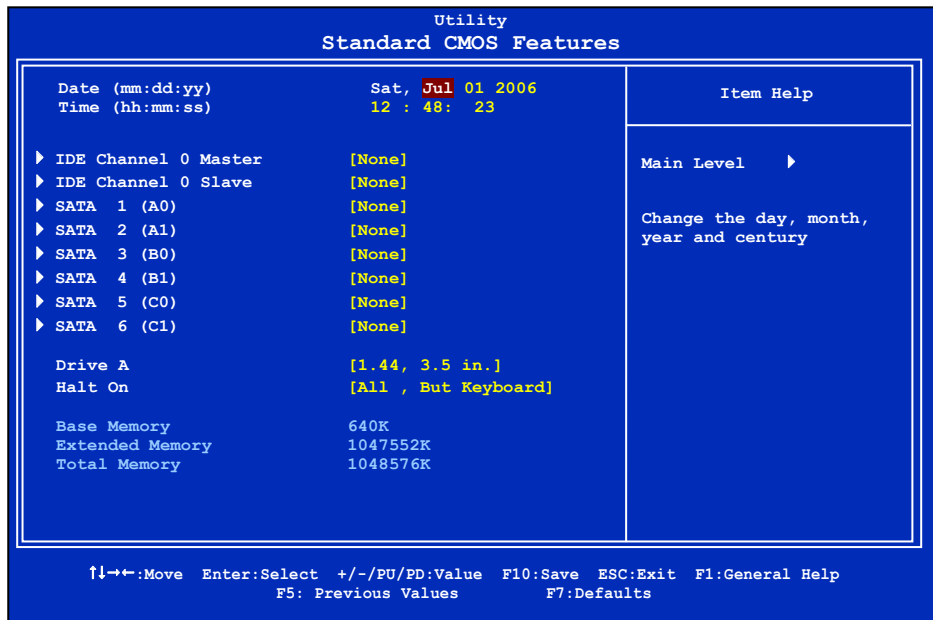

Figure 6. Standard CMOS Features Menu

Note that all data in **white** is for information only, data in **yellow** is changeable, data in **blue** is non-changeable, and data in a **red box** is highlighted for selection.

## Date and Time

Using the arrow keys, position the cursor over the month, day, and year. Use the **Page Up** and **Page Down** keys to scroll through dates and times. Note that the weekday (Sun through Sat) cannot be changed. This field changes to correspond to the date you enter.

Note that the hour value is shown in a 24-hour clock format.

Time is represented as **hour : minute : second**

```
Date (mm:dd:yy)      Sat, Jul 01 2006
Time (hh:mm:ss)     14 : 48: 43
```

## IDE Channel and SATA Channel

Use these functions to detect and configure the individual IDE and SATA channels. Select a channel and press **Enter** to display the IDE/SATA sub-menu.

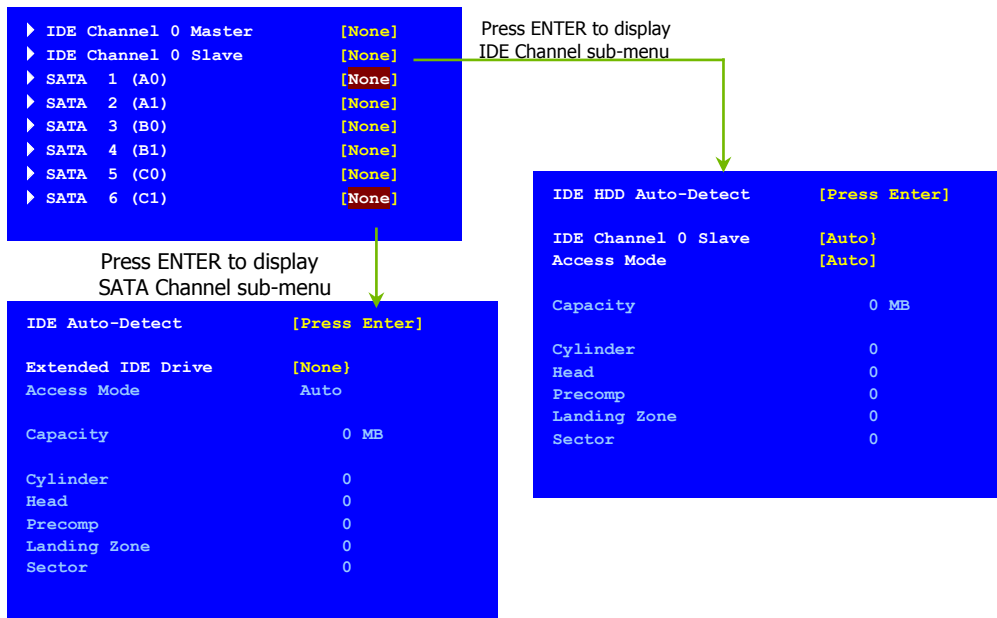

Press **Enter** to auto-detect IDE and SATA channels in the system. Once the channel is detected, the values for Capacity, Cylinder, Heads, Precomp, Landing Zone, and Sector are automatically filled in.

- ❑ **None**  
There is no HDD installed or set.
- ❑ **Auto**  
The system can auto-detect the hard disk when booting up.
- ❑ **Manual**  
When you set the channel to **[Manual]** and change **Access Mode** to **[CHS]**, you can then enter the number of cylinders, heads, Precomp, landing zone, and sector. You can manually enter the values or you can press **Enter** to display a window that tells you the min and max values.



```

IDE HDD Auto-Detect          [Press Enter]

IDE Channel 0 Slave        [Manual]
Access Mode                 [CHS]

Capacity                    0 MB

Cylinder                    0
Head                        [ 0]
Precomp                     [ 0]
Landing Zone                [ 0]
Sector                      [ 0]

```

Press ENTER to display sub-menu  
or

```

Cylinder

Min= 0
Max=65535

Key in a DEC number :

```

---

```

↑↓:Move  ENTER:Accept  ESC:Abort

```

The BIOS supports the following HDD Access Modes:

- **CHS**  
For HDD less than 528 MB.
- **LBA**  
For HDD greater than 528 MB and supporting LBA (Logical Block Addressing).
- **Large**  
For HDD greater than 528 MB but not supporting LBA.
- **Auto**  
Recommended mode.

## Drive A

The **Drive A** option allows you to select the kind of FDD to install. Options are:

```

Drive A                      [1.44, 3.5 in.]
Halt On                       [All , But Keyboard]

```

Press ENTER to display sub-menu

- None
- 360K, 5.25 in.
- 1.2M, 5.25 in.
- 720K, 3.5 in.
- 1.44M, 3.5 in.
- 2.88M, 3.5 in.

Use the **Page Up** and **Page Down** keys to scroll through the options or press **Enter** to display the sub-menu. Use the **↑↓** arrow keys to position the selector in the option you choose. Press **Enter** to accept the changes and return to the Standard CMOS Features menu.

```

Drive A

None          ..... [ ]
360K, 5.25 in. .... [ ]
1.2M, 5.25 in. .... [█]
720K, 3.5 in.  .... [ ]
1.44M, 3.5 in. .... [ ]
2.88M, 3.5 in. .... [ ]

```

---

```

↑↓:Move  ENTER:Accept  ESC:Abort

```

# Halt On

**Halt On** determines whether or not the computer stops if an error is detected during power on. Use the **Page Up** and **Page Down** keys to scroll through the options or press **Enter** to display the **Halt On** sub-menu. Use the **↑↓** arrow keys to position the selector in the option you choose. Press **Enter** to accept the changes and return to the Standard CMOS Features menu.

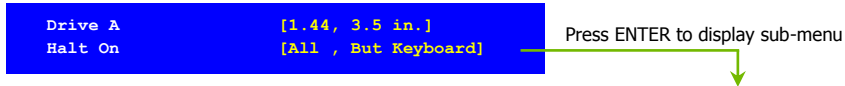

- ❑ **All Errors**  
Whenever the BIOS detects a nonfatal error; the system stops and prompts you.
- ❑ **No Errors**  
System boot does not stop for any detected errors.
- ❑ **All, But Keyboard**  
System boot does not stop for keyboard errors, but does stop for all other errors.
- ❑ **All, But Diskette**  
The system boot does not stop for a diskette error but will stop for all other errors.
- ❑ **All, But Disk/Key**  
The system boot does not stop for a keyboard or disk error, but will stop for all other errors.

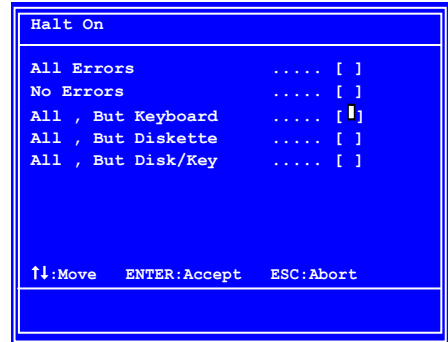

# Memory

These settings are *display-only values* that are determined by the BIOS POST (Power-On Self Test).

- ❑ **Base Memory**  
BIOS POST determines the amount of base (or conventional) memory installed in the system.

Base Memory	640K
Extended Memory	1047552K
Total Memory	1048576K

- ❑ **Extended Memory**  
BIOS determines how much extended memory is present during the POST.
- ❑ **Total Memory**  
This value represents the total memory of the system.

# Advanced BIOS Features

Access the Advanced BIOS Features menu from the CMOS Utility Setup screen. Use the **Page Up** and **Page Down** keys to scroll through the options or press **Enter** to display the sub-menu. Use the **↑↓** arrow keys to position the selector in the option you choose. To go back to the previous menu, press **Esc**.

The options that have associated sub-menus are designated by a **▶**, which precedes the option. Press **Enter** to display the sub-menus.

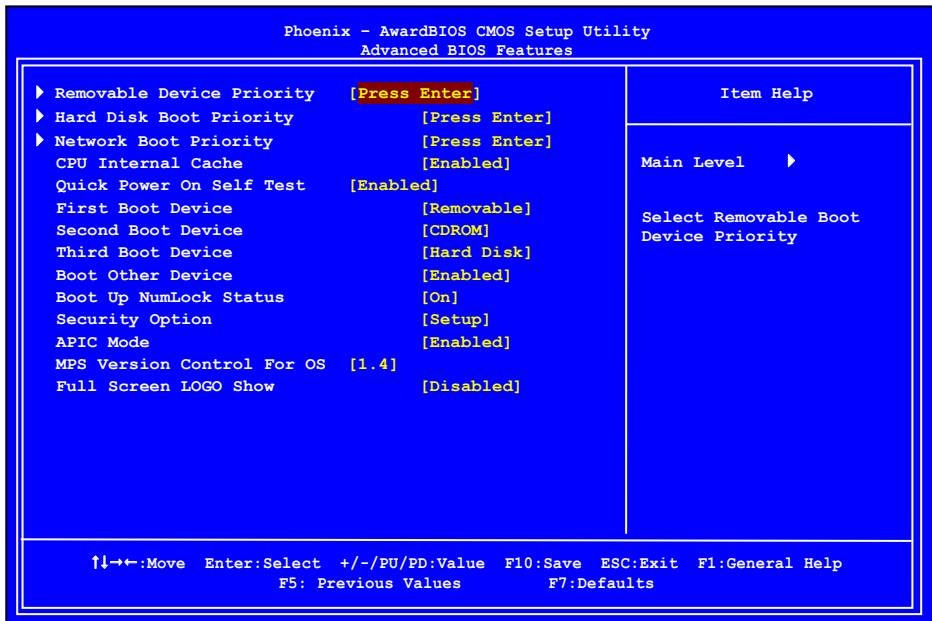

Figure 7. Advanced BIOS Features Menu

Note that all data in **white** is for information only, data in **yellow** is changeable, data in **blue** is non-changeable, and data in a **red box** is highlighted for selection.

## Removable Device Priority

Use this option to select the priority for removable device startup. Press **Enter** to see the list of removable devices in your system. Use the **↑↓** arrow keys to go to the various devices. Then use the **+** or **-** keys to move the device priority up or down in the list. To go back to the previous menu, press **Esc**.

```
1. Floppy Disks
```

## Hard Disk Boot Priority

Use this option to select the priority for HDD startup. Press **Enter** to see the list of bootable devices in your system. Use the **↑↓** arrow keys to go to the various devices. Then use the **+** or **-** keys to move the device priority up or down in the list. To go back to the previous menu, press **Esc**.

```
1. Ch0. : ST3802110A
2. Bootable Add-in Cards
```

Use the **+** and **-** keys to move the priority of the device within the list

## Network Boot Priority

Use this option to select the priority for network startup. Select **Network Boot Priority** and press **Enter** to view available networks. Use the **↑↓** arrow keys to go to the various devices. Then use the **+** or **-** keys to move the device priority up or down in the list. To go back to the previous menu, press **Esc**.

```
1. Network 0 : <description of network>
2. Network 1 : <description of network>
```

## CPU Internal Cache

Use this option to enable or disable the CPU internal cache. Use the **Page Up** and **Page Down** keys to scroll through the options or press **Enter** to display the options in a sub-menu. Use the **↑↓** arrow keys to position the selector in the option you choose.

## Quick Power On Self Test

Enabling this option allows the system to skip certain tests while booting, which reduces the time needed to boot the system. Use the **Page Up** and **Page Down** keys to toggle between **Enable** and **Disable**.

## First/Second/Third Boot Device

Use this option to set the priority sequence of the devices booted at power on. Use the **Page Up** and **Page Down** keys to scroll through the options or press **Enter** to display the sub-menu. Use the **↑↓** arrow keys to position the selector in the option you choose.

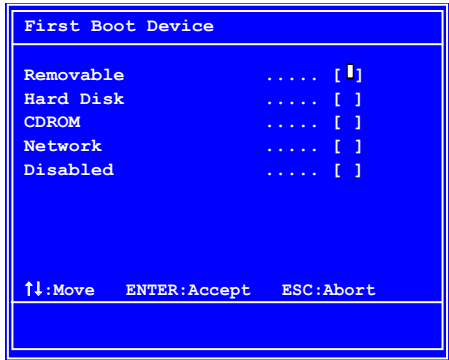

## Boot Other Device

With the option set to **Enable**, the system boots from some other device if the first/second/third boot devices fail.

## Boot Up NumLock Status

This option allows you to select the power-on state of **NumLock**. Select **On** to activate the keyboard **NumLock** when the system is started. Select **Off** to disable the **NumLock** key.

## Security Option

The Security Options allows you to require a password every time the system boots or only when you enter setup. Select **Setup** to require a password to gain access to the CMOS Setup screen. Select **System** to require a password to access the CMOS Setup screen and when the system boots.

## APIC Mode

Use this function to enable or disable the Advanced Programmable Interrupt Controller (APIC). If you disable this option, you also disable the MPS Version Control for OS option.

## MPS Version Control For OS

Use this function to select the Multi-Processor Specification (MPS) version that BIOS passes to the operating system. Use the **Page Up** and **Page Down** keys to scroll through the options.

## Full Screen LOGO Show

This option allows you to enable or disable the display of the full-screen logo when the system boots. Use the **Page Up** and **Page Down** keys to toggle between **Enable** and **Disable**

---

# Advanced Chipset Features

Select **Advanced Chipset Features** from the CMOS Setup Utility menu and press **Enter** to display the functions of the Advanced Chipset Features menu.



Figure 8. Advanced Chipset Features

## System BIOS Cacheable

This function allows you to enable or disable caching the system BIOS.

## HPET Function

This function allows you to enable or disable the High Precision Even Timer (HPET). When **Enabled**, HPET is used as the timing hardware for multimedia and other time-sensitive application. When HPET is **Disabled**, the APIC timer is used.

# Integrated Peripherals Menu

Select **Integrated Peripherals** from the CMOS Setup Utility menu and press **Enter** to display the Integrated Peripherals menu.

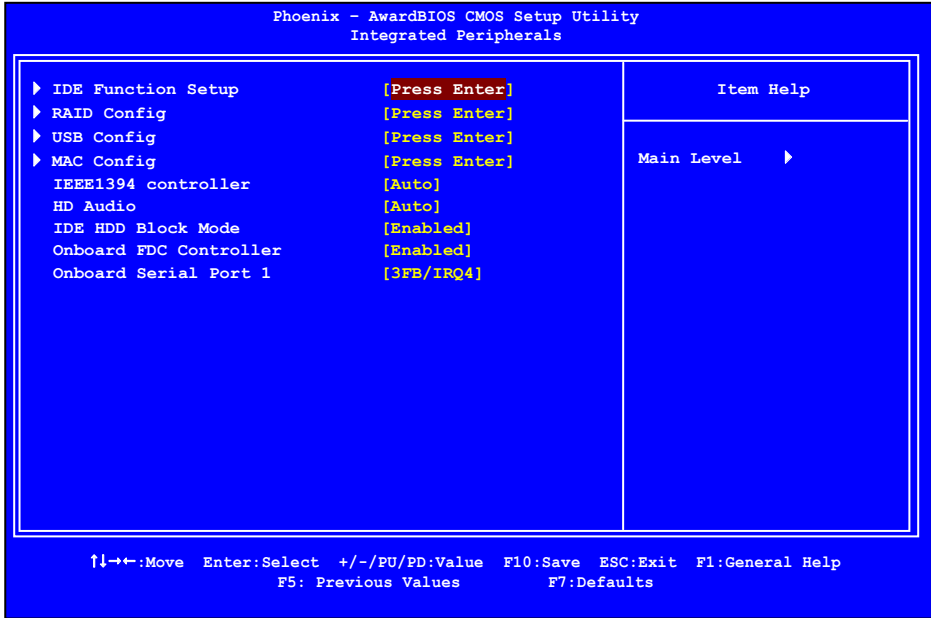

Figure 9. Integrated Peripherals Menu



# IDE Function Setup

Press **Enter** to display the IDE Function Setup menu.

```
OnChip IDE Channel0      [Enabled]
Primary Master   PIO     [Auto]
Primary Slave   PIO     [Auto]
Primary Master   UDMA    [Auto]
Primary Slave   UDMA    [Auto]
IDE DMA transfer access [Enabled]
Serial-ATA Controller [All Enabled]
IDE Prefetch Mode [Enabled]
```

## ❑ OnChip IDE Channel0

Use this function to enable or disable the onchip IDE Channel0. When disabled, the Primary Master/Slave functions are changed to **Auto** and cannot be changed.

```
OnChip IDE Channel0      [Disabled]
x Primary Master   PIO     Auto
x Primary Slave   PIO     Auto
x Primary Master   UDMA    Auto
x Primary Slave   UDMA    Auto
IDE DMA transfer access [Enabled]
Serial-ATA Controller [All Enabled]
IDE Prefetch Mode [Enabled]
```

## ❑ Primary Master/Slave PIO

When **OnChip IDE Channel0**

is set to **[Enabled]**, you can select a mode for the primary Master and Slave PIO. Select from **Auto**, or **Mode 1** through **Mode 4**.

## ❑ Primary Master/Slave UDMA

When **OnChip IDE Channel0** is set to **[Enabled]**, you can disable the primary Master and Slave UDMA or set it to **[Auto]**.

## ❑ IDE DMA transfer access

Use this function to enable or disable IDE DMA transfer access.

## ❑ Serial-ATA Controller

This function allows you to enable specific SATA controllers, enable all controllers, or disable all controllers. The options available are **[SATA-0]**, **[SATA-0+1]**, **[Enable All]**, and **[Disabled]**.

## ❑ IDE Prefetch Mode

Use this function to enable or disable the IDE Prefetch mode.

# RAID Config

Press **Enter** to display the RAID Config menu.

```
RAID Enable           [Enabled]
SATA 0 Primary        RAID   [Disabled]
SATA 0 Secondary      RAID   [Disabled]
SATA 1 Primary        RAID   [Disabled]
SATA 1 Secondary      RAID   [Disabled]
SATA 2 Primary        RAID   [Disabled]
SATA 2 Secondary      RAID   [Disabled]
```

### RAID Enable

Use this function to enable or disable RAID. When RAID is set to **[Disabled]**, all SATA functions are changed to **Disabled** and cannot be changed.

```
RAID Enable           [Disabled]
x SATA 0 Primary      RAID   Disabled
x SATA 0 Secondary    RAID   Disabled
x SATA 1 Primary      RAID   Disabled
x SATA 1 Secondary    RAID   Disabled
x SATA 2 Primary      RAID   Disabled
x SATA 2 Secondary    RAID   Disabled
```

### SATA x Primary/Secondary

When **RAID Enable** is set to **[Enabled]**, you can enable or disable the various SATA functions.

# USB Config

Press **Enter** to display the USB Config menu.

```
OnChip USB           [Enabled]
USB Keyboard Support  [Disabled]
USB Mouse Support     [Disabled]
```

### OnChip USB

Use this function to enable specific versions of the USB or disable the onchip USB. When the onchip USB is set to **[Disabled]**, the keyboard and mouse support functions are set to **Enabled** and cannot be changed. Versions that can be selected are **[V1.1+V2.0]** or **[V1.1]**.

### USB Keyboard/Mouse Support

Use these function to enable or disable the onchip WSB support of the keyboard and/or mouse.

```
OnChip USB           [Disabled]
x USB Keyboard Support Enabled
x USB Mouse Support  Enabled
```

## MAC Config

Press **Enter** to display the MAC Config menu.

MAC0 LAN	[Enabled]
MAC1 LAN	[Disabled]

### MACx LAN

Use these functions to set the MAC0 and/or MAC1 LANs to **Auto** or disable their functions.

## IEEE1394 controller

This function on the Integrated Peripherals menu allows you to enable or disable the IEEE1394 (Firewire) interface.

## HD Audio

This function on the Integrated Peripherals menu allows you to enable or disable the integrated high definition audio.

## IDE HDD Block Mode

Using this function on the Integrated Peripherals menu allows your IDE hard drive needs to support block mode. Select **[Enabled]** to automatically detect the optimal number of block read/writes per sector the drive can support. Select **[Disabled]** if your drive does not support block mode.

## Onboard FDC Controller

This function on the Integrated Peripherals menu allows you to enable or disable the onboard Floppy Disk Controller function.

## Onboard Serial Port 1

This function on the Integrated Peripherals menu allows you to select the onboard serial port 1 function. Options are **[3F8/IRQ4]**, **[2E8/IRQ3]**, **[3E8/IRQ4]**, **[Auto]**, and **[Disabled]**.

# Power Management Setup Menu

Select **Power Management Setup** from the CMOS Setup Utility menu and press **Enter** to display the Power Management Setup menu.

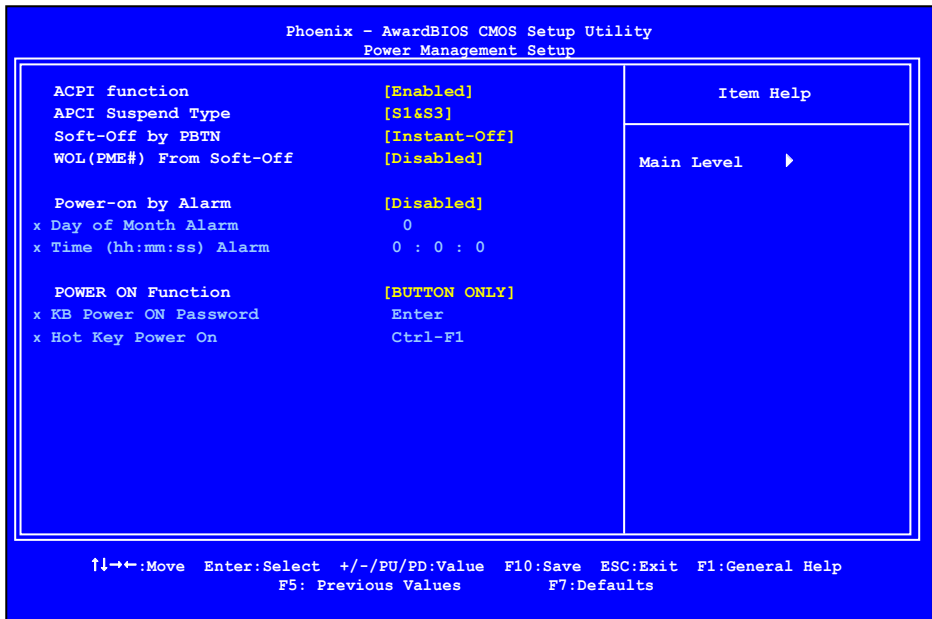

Figure 10. Power Management Setup Menu

## ACPI Function

This function on the Power Management Setup menu allows you to enable or disable the ACPI function.

## ACPI Suspend Type

This function on the Power Management Setup menu allows you to select an ACPI Suspend Type. Types to select from are **[S1&S3]**, **[S1 (POS)]**, and **[S3 (STR)]**.

## Soft-Off by PBNT

This function on the Power Management Setup menu allows you to set Soft-Off by PBNT to **[Instant-Off]** or **[Delay 4 Sec]**.

## WOL(PME#) From Soft-Off

This function on the Power Management Setup menu allows you to enable or disable WOL(PMW#) from soft-off.

## Power On by Alarm

This function on the Power Management Setup menu allows you to enable or disable the Power-on by alarm function. Set to **[Disable]** to prevent power-on by alarm. When set to **[Enable]**, you can manually put in the day of the month and the time of the alarm.

```
Power-on by Alarm           [Disabled]
Day of Month Alarm         [ 0 ]
Time (hh:mm:ss) Alarm     [0 : 0 : 0]
```

To enter a day or time, use the **Page Up** and **Page Down** keys to scroll through numbers or enter the number using the keyboard number or the **+** and **-** keys.

## POWER ON Function

This function on the Power Management Setup menu allows you to define the power-on function. Options for this function are:

- BUTTON ONLY**
- Keyboard 98**
- Password**

When [**Password**] is selected, the **KB Power ON Password** function is enabled so that you must enter a password.

POWER ON Function	[Password]
KB Power ON Password	[Enter]
x Hot Key Power On	Ctrl-F1

- Hot Key Power On**

When [**Hot Key**] is selected, the **Hot key Power On function** is enabled so that you must select a keyboard key as the hot key. To select a hot key use **Ctrl+F1** though **Ctrl+F12**

POWER ON Function	[Hot key]
x KB Power ON Password	Enter
Hot Key Power On	[Ctrl-F1]

- Mouse Left**
- Mouse Right**
- Any Key**

---

# PnP/PCI Configuration Menu

Select **PnP/PCI Configuration** from the CMOS Setup Utility menu and press **Enter** to display the PnP/PCI Configuration menu.

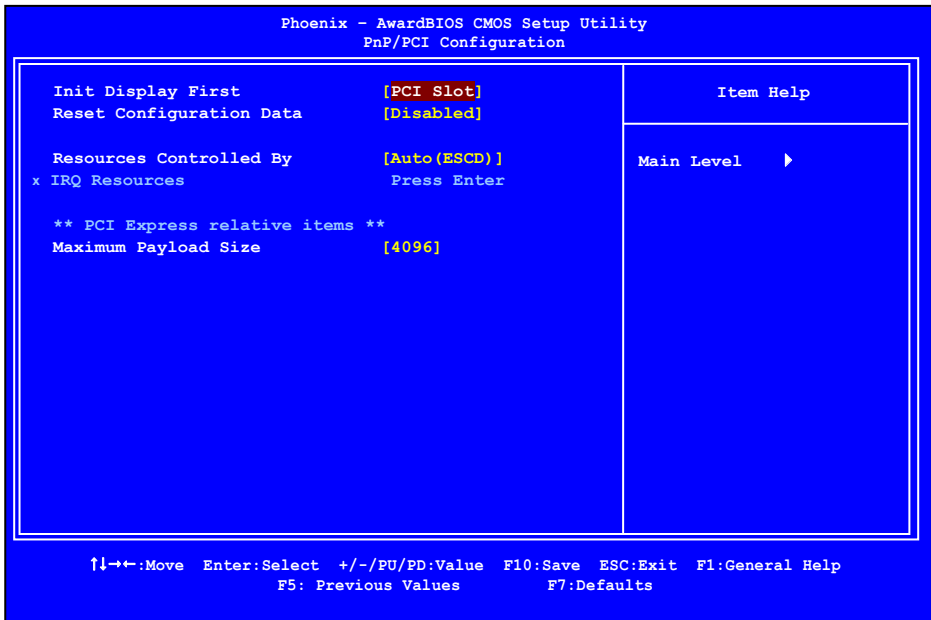

Figure 11. PnP/PCI Configuration Menu

## Init Display First

This function on the PnP/PCI Configuration menu allows you to define if the initial display is in the PCI slot or in the PCI Express slot. Options are [PCI Slot] and [PCIEx].

## Reset Configuration Data

This function on the PnP/PCI Configuration menu allows you to enable or disable the resetting of Extended System Configuration Data (ESCD) when you exit Setup.

Set this to **[Enabled]** if you have installed a new add-on and the system reconfiguration has caused a serious conflict that prevents the OS from booting. The default setting is **[Disabled]**.

## Resources Controlled By

This function on the PnP/PCI Configuration menu allows you to define if the BIOS can automatically configure all the boot and plug-and-play compatible devices or if you can manually select IRQ, DMA, and memory base address fields. Select **[Auto (ESCD)]** if you want the BIOS to automatically populate these fields. If you select **[Manual]** so you can assign the resources, **IRQ Resources** is enabled for input.

```
Resources Controlled By  [Auto (ESCD)]
x IRQ Resources          Press Enter
```

```
Resources Controlled By  [Manual]
IRQ Resources            [Press Enter]
```

## IRQ Resources

To enable this field for input, set **Resources Controlled By** to **[Manual]**. With this field enabled, press **Enter** to see options.

```
IRQ-5 assigned to      [PCI Device]
IRQ-9 assigned to      [Reserved]
IRQ-10 assigned to     [PCI Device]
IRQ-11 assigned to     [PCI Device]
IRQ-14 assigned to     [PCI Device]
IRQ-15 assigned to     [PCI Device]
```

Use Legacy ISA for devices compliant with the original PC AT Bus specification. Use PCI/ISA PnP for devices compliant with the plug-and-play standard, whether designed for PCI or ISA Bus architecture.

## PCI/VGA Palette Snoop

This function on the PnP/PCI Configuration menu allows you to enable or disable the Palette Snoop function.



# Maximum Payload Size

This function on the PnP/PCI Configuration menu allows you to set the maximum TLP payload size (in bytes) for the PCI Express devices. Use the **Page Up** and **Page Down** keys to scroll through sizes or enter the number using the keyboard numbers or use the **+** and **-** keys to go up and down the list of sizes.

---

# PC Health Status

Select **PC Health Status** from the CMOS Setup Utility menu and press **Enter** to display the PC Health Status menu.

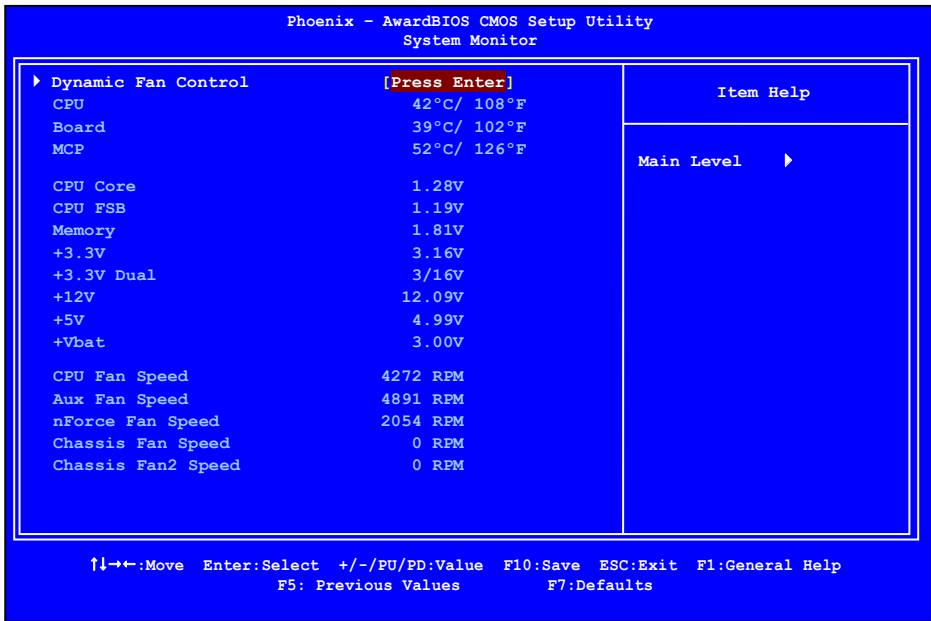

Figure 12. PC Health Status

All of the values shown in **Blue** are dynamic and change as the speed and voltages of the various components change with system usage.

## Dynamic Fan Control

Press **Enter** to display the Dynamic Fan Control menu.

```
CPU Fan Speed Control      [SmartFan]
If temp > 70°C, Set Fan Speed 100%
If temp < 30°C, Set Fan Speed 1%
x Manual Fan Speed, %      100
Chassis Fan Speed Control, % [SmartFan]
If temp > 70°C, Set Fan Speed 100%
If temp < 30°C, Set Fan Speed 1%
x Manual Fan Speed, %      100

nForce Fan Speed Control, % [SmartFan]
x Manual Fan Speed, %      100

AUX Fan Speed Control, % [100]
Chassis Fan2 Speed Control, % [100]
```

Use this menu to control the speed of the various fans on the motherboard. Set CPU fan speed, Chassis Fan, and nForce Fan to **[SmartFan]** when you want the speed of the fans automatically controlled based on temperature. To set the fan speed to a constant rate, select **[Manual]** and then enter the speed from 0% to 100%.

Set the desired speed for the AUX, and Chassis fans from 0% to 100%. The system defaults to 100%.



# Frequency/Voltage Control

Press **Enter** to display the sub-menus.

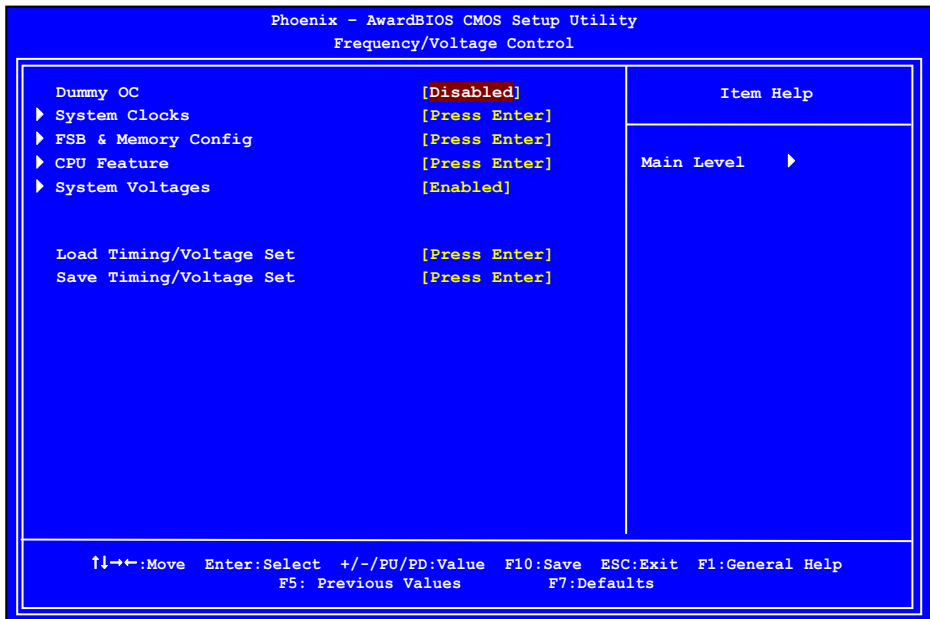

## Dummy O.C

Choose different levels of CPU OC 5%, 10%, 15%, 20%, and 25% increments. This function will allow to automatically overclock your CPU. The O.C's stability will rely on the CPU type, good CPU's heat dissipation, O.C memory modules and so on.

## System Clocks

Select **System Clocks** from the Advanced Chipset Features menu and press **Enter** to display the System Clocks menu. From this menu, you are able to specify frequency settings, HT multipliers, and Spread Spectrum settings. Note that in Figure 9, all of the options are listed. On the actual BIOS screen, you will need to scroll down to see all the options.

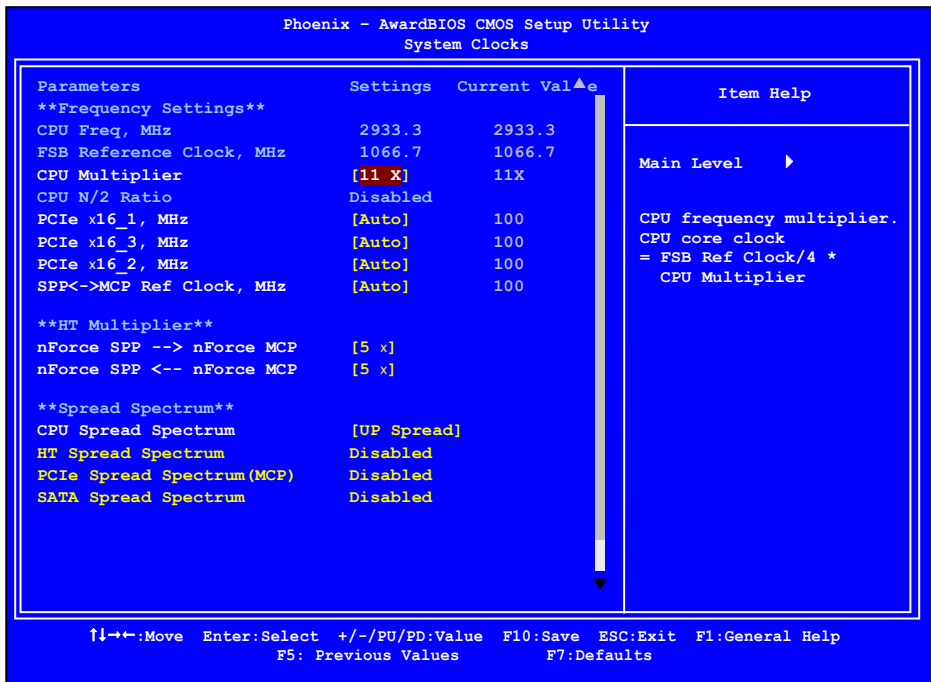

Figure 13. System Clocks Menu

Note that all data in **white** is for information only, data in **yellow** is changeable, data in **blue** is non-changeable, and data in a **red box** is highlighted for selection.

## Frequency Settings

### ❑ CPU Freq, MHz

This value is set by the CPU Multiplier (value cannot be changed by the user).

### ❑ FSB Reference Clock, MHz

This value is set by the system (value cannot be changed by the user). To change the SLI-Ready memory, FSB memory, and memory timing, go to the FSB & Memory screen.

### ❑ CPU Multiplier

This value changes the CPU Frequency value depending on the value you choose. Use the **Page Up** and **Page Down** keys to scroll through the options. The options are from 6 X through 60 X.

### ❑ PCIe x16\_1, MHz

Use the **Page Up** and **Page Down** keys to scroll through the frequency options for the PCI Express Bus, Slot 1 (the black slot closest to the CPU). Note that as you go higher in value, **PCIe Spread Spectrum (SPP)** is disabled and cannot be changed from this status.

### ❑ PCIe x16\_3, MHz

Use the **Page Up** and **Page Down** keys to scroll through the frequency options for the PCI Express Bus, Slot 3 (the blue slot in the middle).

### ❑ PCIe x16\_2, MHz

Use the **Page Up** and **Page Down** keys to scroll through the frequency options for the PCI Express Bus, Slot 3 (the black slot farthest from the CPU).

### ❑ SPP<-->MCP Ref Clock, MHz

Use the **Page Up** and **Page Down** keys to scroll through the frequency options for the reference clock between the SPP chip and the MCP chip.

## HT Multiplier

### ❑ nForce SPP --> nForce MCP

Use the **Page Up** and **Page Down** keys to scroll through the HT multiplier options and set the link speed from the SPP chip to the MCP chip. Values are [1 x] through [5 x].

### ❑ nForce MCP <-- nForce SPP

Use the **Page Up** and **Page Down** keys to scroll through the HT multiplier options and set the link speed from the MCP chip to the SPP chip. Values are [1 x] through [5 x].

## Spread Spectrum

- ❑ **CPU Spread Spectrum**

Use the **Page Up** and **Page Down** keys to scroll through the Spread Spectrum options for the CPU. Option values are **[Disabled]**, **[UP Spread]**, and **[Center Spread]**.

- ❑ **HT Spread Spectrum**

Disabled

- ❑ **PCIe Spread Spectrum(MCP)**

Disabled

- ❑ **SATA Spread Spectrum**

Disabled

## FSB & Memory Config

Select **FSB & Memory Config** from the Advanced Chipset Features menu and press **Enter** to display the FSB & Memory Config menu. This menu provides the means to set SLI-Ready memory, FSB memory, and memory timing.

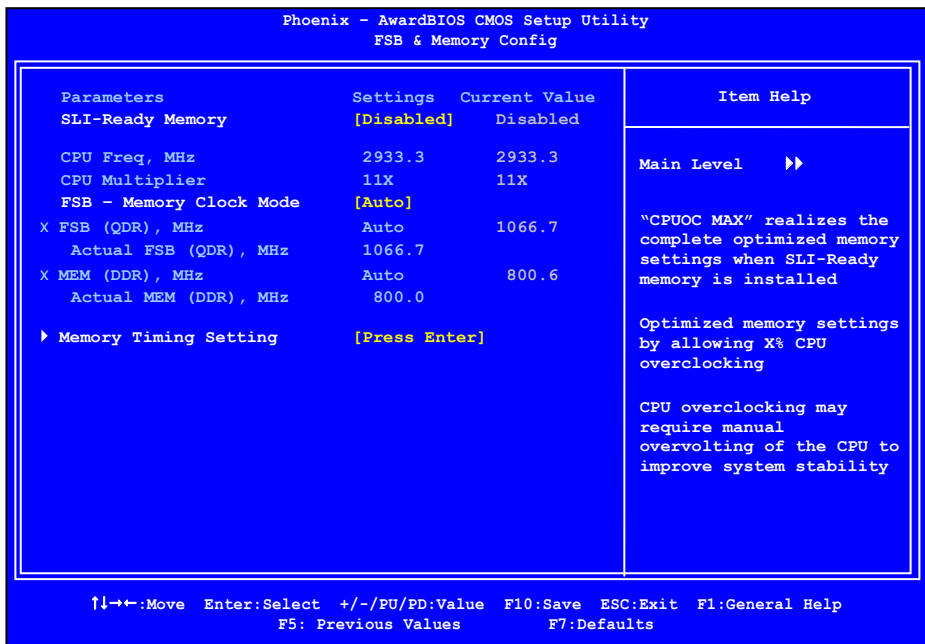

Figure 14. FSB & Memory Config Menu

### ❑ SLI-Ready Memory

Use the **Page Up** and **Page Down** keys to scroll through the SLI-Ready Memory options. The options are:

- Disabled
- CPUOC 0%
- CPUOC 1%
- CPUOC 2%
- CPUOC 3%
- CPUOC 4%
- CPUOC 5%
- CPUOC MAX
- Expert



When you select one of the **CPUOC x%** options, the **FSB - Memory Clock Mode** is set to **Unlinked** and cannot be changed until **SLI-Ready Memory** is set to **Disable**. Please note when enabling SLI-Ready memory, timings and voltages will change automatically based on selection.

#### ❑ **FSB and Memory Clock Mode**

Use the **Page Up** and **Page Down** keys to scroll through the FSB and Memory Clock Mode options. The options are:

##### ➤ **Auto**

This is the optimal setting since it sets the FSB and memory speeds automatically.

##### ➤ **Linked**

When **Link** is selected, **FSB (QDR), MHz** is changed to editable and the FSB speed can be entered manually. As the FSB speed is changed, **CPU Freq, MHz** changes proportionally.

CPU Freq, MHz	2933.3	2933.3
CPU Multiplier	11X	11X
FSB - Memory Clock Mode	[Linked]	
FSB (QDR), MHz	[1067]	1066.7
Actual FSB (QDR), MHz	1066.7	
X MEM (DDR), MHz	Auto	800.6
Actual MEM (DDR), MHz	800.0	

##### ➤ **Unlinked**

When **Unlink** is selected, **FSB (QDR), MHz** and **MEM (DDR), MHz** are changed to editable and the FSB and memory speeds can be entered manually. As the FSB speed is changed, **CPU Freq, MHz** changes proportionally.

FSB - Memory Clock Mode	[Linked]	
FSB (QDR), MHz	[1067]	1066.7
Actual FSB (QDR), MHz	1066.7	
MEM (DDR), MHz	[1067]	800.6
Actual MEM (DDR), MHz	800.0	

#### ❑ **FSB (QDR), MHz**

Use the **+** or **-** keys to scroll through new values for the CPU FSB frequency or type in a new value. Note that the **Actual FSB (QDR)** reflects the actual frequency that takes effect on a reboot.

#### ❑ **MEM (DDR), MHz**

Use the **+** or **-** keys to scroll through new values for the memory frequency or type in a new value. Note that the **Actual MEM (DDR)** reflects the actual frequency that takes effect when the system reboots.

## ❑ Memory Timing Setting

Press **Enter** to display the Memory Timing Setting menu. Use this menu to set optimal timings or to manually enter timings.

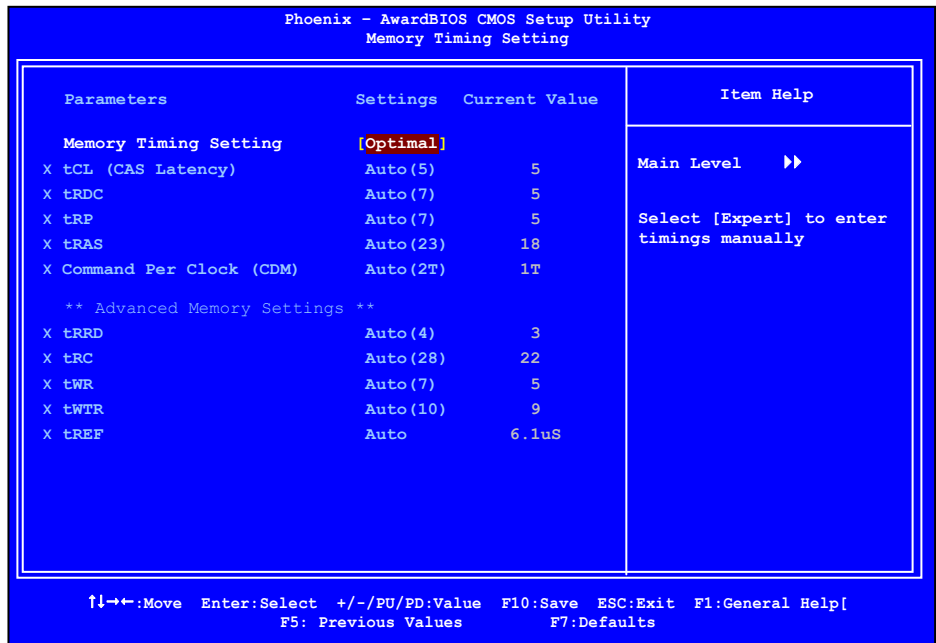

### ➤ Optimal

Use the **Page Up** and **Page Down** keys to select **Optimal**. Optimal prohibits you from manually setting any timing. All timing is set for optimal performance.

### ➤ Expert

Use the **Page Up** and **Page Down** keys to select **Expert**. When Expert is selected, all timing categories are enabled for manual input. Note that you should set the value to Optimal to use the manufacturers' recommended values.

Parameters	Settings	Current Value
Memory Timing Setting	[Expert]	
tCL (CAS Latency)	[Auto (5) ]	5
tRDC	[Auto (7) ]	5
tRP	[Auto (7) ]	5
tRAS	[Auto (23) ]	18
Command Per Clock (CDM)	[Auto (2T) ]	1T
** Advanced Memory Settings **		
tRRD	[Auto (4) ]	3
tRC	[Auto (28) ]	22
tWR	[Auto (7) ]	5
tWTR	[Auto (10) ]	9
tREF	[Auto]	6.1uS

**tCL:** CAS# latency (options are 1 through 6).

**tRDC:** RAS#-to-CAS# Delay for Read/Write commands to the same bank (options are 1 through 7).

**tRP:** Row Precharge time. This is the Precharge-to-Active or Auto-to-Refresh of the same bank (options are 1 through 7).

**tRAS:** This is the minimum RAS# active time (options are 1 through 31).

**Command Per Clock:** This is the command timing setting on a per clock unit basis (options are 1T and 2T).

**tRRD:** RAS#-to-RAS# delay of different banks (options are 1 through 15).

**tRC:** RAS#-to-RAS# or auto refresh time of the same bank (options are 1 through 31).

**tWR:** The Write recovery time (options are 2 through 7).

**tWTR:** This is the minimum write-to-read delay with the same chip selected (options are 1 through 10).

**tREF:** This is the DRAM refresh rate (options are **Auto**, **7.8uS**, and **3.9uS**).

# CPU Feature

Select **CPU Feature** from the Frequency/Voltage control menu and press **Enter** to display the CPU Feature menu.

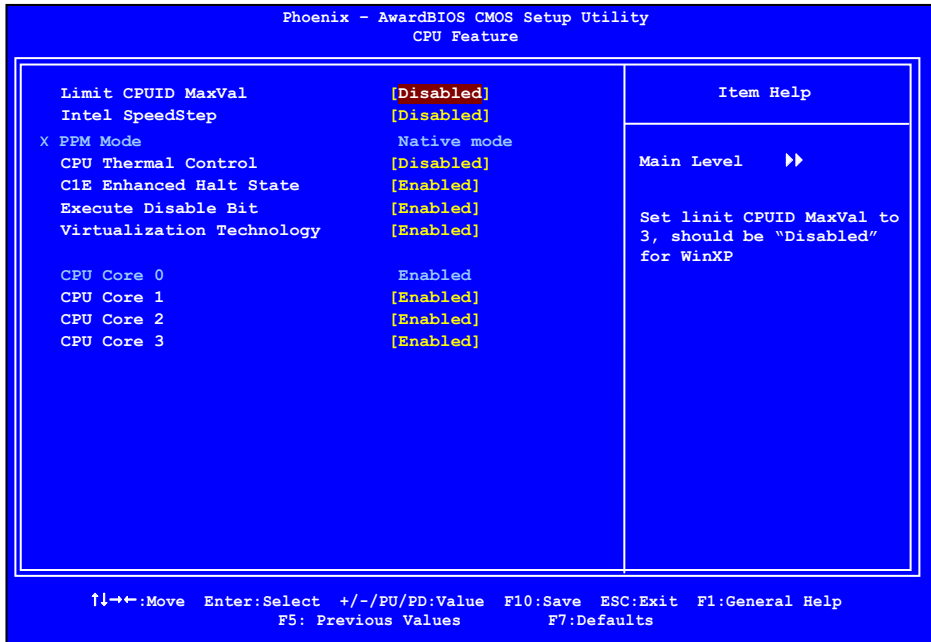

Figure 15. CPU Configuration Menu

### ❑ Limit CPUID MaxVal

Use this function to enable the set limit of the CPUID MaxVal to 3. Set to Disable for Win XP.

### ❑ Intel SpeedStep

If enabled, CPU clock speed and CPU core voltage are adjusted dynamically based on the CPU load.

### ❑ PPM Mode

Options are Native mode and SSM mode.

❑ **CPU Thermal Control**

Use this function to enable or disable TM1 and TM2 support. Options are:

➤ **Disable**

Disable support for TM1 and TM2.

➤ **TM1 Only**

The CPU is thermally throttled by cutting active processor clock cycles.

➤ **TM2 Only**

Thermal throttling is achieved by reducing the CPU multiplier and CPU core voltage.

➤ **TM1 & TM2**

Enables support for both TM1 and TM2.

❑ **C1E Enhanced Halt State**

Enabled, this function reduces the CPU power consumption when the CPU is idle. Idle occurs when the operating system issues a halt instruction.

❑ **Execute Disable Bit**

When this function is disabled, it forces the XD feature flag to always return to zero (0).

❑ **Virtualization Technology**

When this function is enabled, it allows a VMM to utilize the additional hardware capabilities provided by Intel Virtualization Technology.

❑ **CPU Core 1-3**

This function allows you to enable or disable CPU Cores.

# System Voltages

Select **System Voltages** from the Advanced Chipset Features menu and press **Enter** to display the System Voltages menu.

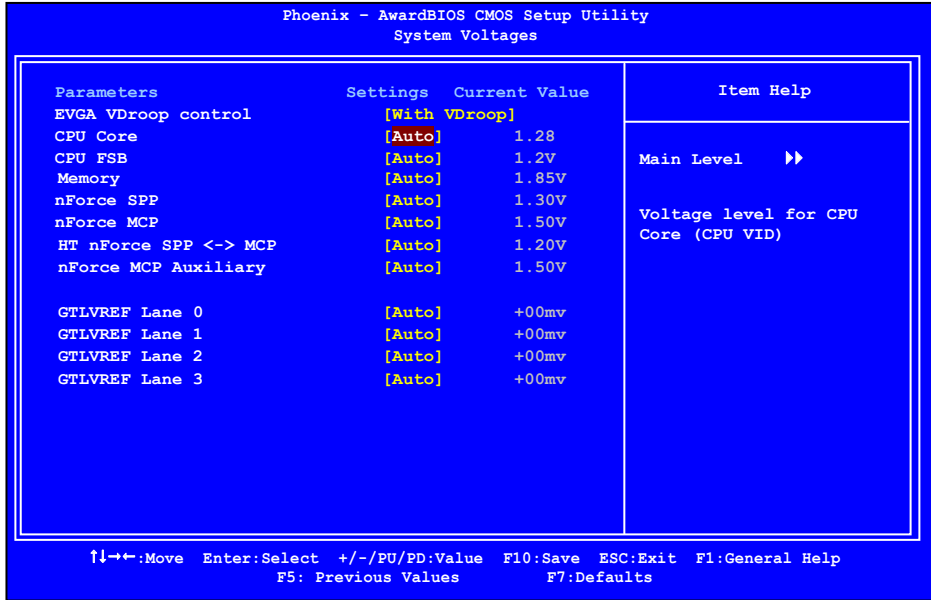

Figure 16. System Voltages Menu

## ❑ EVGA VDroop control

This Function offers options of **With VDroop** or **Without VDroop** to reduce voltage droop.

## ❑ CPU Core

Use the **Page Up** and **Page Down** keys to scroll through the voltages or select **[Auto]** to automatically set the voltage level for the CPU Core.

## ❑ CPU FSB

Use the **Page Up** and **Page Down** keys to scroll through the voltages or select **[Auto]** to automatically set the voltage level for the CPU FSB.

## ❑ Memory

This function defines the voltage level for the DRAM. Use the **Page Up** and **Page Down** keys to select a voltage or select **[Auto]** to automatically set the voltage.

## ❑ nForce SPP

This function defines the core voltage level for the NVIDIA nForce SPP chip. Use the

**Page Up** and **Page Down** keys to select a voltage (1.20V, 1.30V, 1.40V, 1.50V) or select **[Auto]** to automatically set the voltage.

❑ **nForce MCP**

This function defines the core voltage level for the NVIDIA nForce MCP chip. Use the **Page Up** and **Page Down** keys to select a voltage or select **[Auto]** to automatically set the voltage.

❑ **HT nForce SPP <-> MCP**

This function defines the voltage level for the NVIDIA HT nForce SPP <-> MCP Link. Use the **Page Up** and **Page Down** keys to select a voltage or select **[Auto]** to automatically set the voltage.

❑ **nForce MCP Auxiliary**

This function defines the core voltage level for the NVIDIA nForce MCP Auxiliary voltage. Use the **Page Up** and **Page Down** keys to select a voltage or select **[Auto]** to automatically set the voltage.

❑ **GTLVREF Lane 0**

This function defines the voltage level for GTLVREF Lane 0. Use the **Page Up** and **Page Down** keys to select a voltage or select **[Auto]** to automatically set the voltage.

❑ **GTLVREF Lane 1**

This function defines the voltage level for GTLVREF Lane 1. Use the **Page Up** and **Page Down** keys to select a voltage or select **[Auto]** to automatically set the voltage.

❑ **GTLVREF Lane 2**

This function defines the voltage level for GTLVREF Lane 2. Use the **Page Up** and **Page Down** keys to select a voltage or select **[Auto]** to automatically set the voltage.

❑ **GTLVREF Lane 3**

This function defines the voltage level for GTLVREF Lane 3. Use the **Page Up** and **Page Down** keys to select a voltage or select **[Auto]** to automatically set the voltage.

## NVMEM Memory Test

This function defines whether you run the NVIDIA memory testing module during POST. The options are Fast, Medium, Slow, and Disable.

## Load Timing/Voltage Set

This function loads the system voltages and timing settings that were defined in the System Voltages menu. You can set up to four profile settings using the **Save timing/voltage set** function.

There are four profile options that can be loaded. Press **Enter** to see the options.



## Save Timing/Voltage Set

This function saves the system voltages and timing settings that were defined in the System Voltages menu. There are four profile options that can be loaded.

Press **Enter** to see the options.

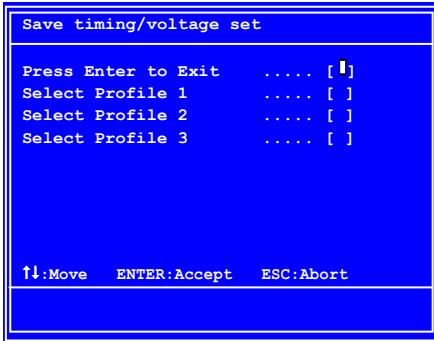





# Installing Drivers and Software

It is important to remember that *before* installing the driver CD that is shipped in the kit, you need to load your operating system. This motherboard supports both Windows XP 32-bit 64-bit and is Vista-capable with both 32-bit and 64-bit.

The kit comes with a CD that contains drivers and additional NVIDIA software.

The CD that has been shipped with your EVGA motherboard contains the following software and drivers:

- ❑ NVIDIA nForce motherboard drivers
- ❑ Audio drivers
- ❑ RAID drivers
- ❑ Adobe Acrobat Reader
- ❑ User's Manual

---

## Driver Installation

3. Insert the EVGA nForce 780i SLI FTW installation CD for the motherboard included in the kit.
4. The CD will autorun, install the drivers and utilities listed on the install screen.

If the CD does not run, go to My Computer and click on the CD to open.



## EVGA Glossary of Terms:

ACPI - Advanced Configuration and Power Interface

AFR – Alternate Frame Rendering

APIC - Advanced Programmable Interrupt Controller

BIOS - Basic Input Output System

CD-ROM - Compact Disc Read-Only Memory

CMOS - Complementary Metal-Oxide Semiconductor

CPU – Central Processing Unit

D-ICE – Dry Ice Cooling

DDR2 - Double Data Rate 2

DDR3 - Double Data Rate 3

DIMM - Dual In-line Memory Module

DRAM - Dynamic random access memory

DVD - Digital Versatile Disc

DVI – Digital Video Interface

FDC - Floppy Disk Controller

FSB – Front Side Bus

FTW – For The Win!

GHz – Gigahertz

GPU – Graphics Processing Unit

HDD - Hard Disk Drive

HDMI - High-Definition Multimedia Interface

HDR – High Dynamic Range Lighting

HPET - High Precision Event Timer

HSF - Heat Sink Fan

I/O - Input/Output

IDE - Integrated Drive Electronics

IEEE - Institute of Electrical and Electronics Engineers

IGP - Integrated Graphics Processors

IRQ - Interrupt Request

JBOD - Just a Bunch of Disks

JEDEC - Joint Electron Device Engineering Council

LAN - Local Area Network

LCD - Liquid Crystal Display  
LGA – Land Grid Array  
LN2 – Liquid Nitrogen Cooling  
MAC - Media Access Control  
MCP - Media and Communications Processor  
MHz - Megahertz  
NB - Northbridge  
NCQ - Native Command Queuing  
NIC - Network Interface Card  
NTFS - New Technology File System  
OEM - Original Equipment Manufacturer  
PATA - Parallel Advanced Technology Attachment  
PCB - Printed Circuit Board  
PCI - Peripheral Component Interconnect  
PCIe - Peripheral Component Interconnect Express  
PCI-x - Peripheral Component Interconnect Extended  
POST – Power on Self Test  
QDR - Quad Data Rate  
RAID - Redundant Array of Inexpensive Disks  
RGB - Red Green Blue  
SATA - Serial Advanced Technology Attachment  
SB - Southbridge  
SCSI - Small Computer System Interface  
SFR – Split Frame Rendering  
SLI - Scalable Link Interface  
SPD - Serial Presence Detect  
SPDIF - Sony/Philips Digital Interconnect Format  
SPP - System Platform Processors  
TCP/IP - Transmission Control Protocol/Internet Protocol  
USB - Universal Serial Bus  
VDroop - V-core Voltage Drop  
VGA - Video Graphics Array

# Appendix A. POST Codes for the EVGA nForce 780i SLI FTW Motherboard



This section provides the Award POST Codes (Table 6) and the NVMM POST Codes (Table 7) for EVGA nForce 780i SLI FTW Motherboard during system boot up.

These POST Codes are displayed on the LED POST Code readout located directly onboard the motherboard. Only (Table 6) Codes will display on the LED POST Code readout.

**Table 6. Award POST Code**

<b>Award POST Codes</b>		
<b>Code</b>	<b>Name</b>	<b>Description</b>
01	Reserved	
02	Jumps to E000 segment	Execution of POST routines in E000
03	Early SuperIO	Init Early Initialized the super IO
04	Reserved	
05	Blank video	Reset Video controller
06	Reserved	
07	Init KBC	Keyboard controller init
08	KB test	Test the Keyboard
09	Reserved	
0A	Mouse Init	Initialized the mouse
0B	Reserved	
0C	Reserved	
0D	Reserved	

<b>Award POST Codes</b>		
<b>Code</b>	<b>Name</b>	<b>Description</b>
0E	CheckSum Check	Check the integrity of the ROM,BIOS and message
0F	Reserved	
10	Autodetect EEPROM	Check Flash type and copy flash write/erase routines
11	Reserved	
12	Test CMOS	Test and Reset CMOS
13	Reserved	
14	Load Chipset	Load Chipset Defaults
15	Reserved	
16	Init Clock	Initialize onboard clock generator
17	Reserved	
18	Init CPU	CPU ID and initialize L1/L2 cache
19	Reserved	
1A	Reserved	
1B	Setup Interrupt Vector Table	Initialize first 120 interrupt vectors with SPURIOUS_INT_HDLR and initialize INT 00h-1Fh according to INT_TBL
1C	CMOS Battery Check	Test CMOS and check Battery Fail
1D	Early PM	Early PM initialization
1E	Reserved	
1F	Re-initial KB	Load keyboard matrix
20	Reserved	
21	HPM init	Init Heuristic Power Management (HPM)
22	Reserved	
23	Program chipset	Early Programming of chipset registers
24	Init PNP	Init PNP
25	Shadow VBIOS	Shadow system/video BIOS
26	Clock Gen	Init onboard clock generator and sensor
27	Setup BDA	Setup BIOS DATA AREA (BDA)
28	Reserved	
29	CPU Speed detect	Chipset programming and CPU Speed detect
2A	Reserved	
2B	Init video	Initialize Video
2C	Reserved	
2D	Video memory test	Test Video Memory and display Logos

<b>Award POST Codes</b>		
<b>Code</b>	<b>Name</b>	<b>Description</b>
2E	Reserved	
2F	Reserved	
30	Reserved	
31	Reserved	
32	Reserved	
33	Early keyboard reset	Early Keyboard Reset
34	Reserved	
35	Test DMA Controller 0	Test DMA channel 0
36	Reserved	
37	Test DMA Controller 1	Test DMA channel 1
38	Reserved	
39	Test DMA Page Registers	Test DMA Page Registers
3A	Reserved	
3B	Reserved	
3C	Test Timer	Test 8254 Timer 0 Counter 2.
3D	Reserved	
3E	Test 8259-1 Mask	Verify 8259 Channel 1 masked interrupts by alternately turning off and on the interrupt lines.
3F	Reserved	
40	Test 8259-2 Mask	Verify 8259 Channel 2 masked interrupts by alternately turning off and on the interrupt lines.
41	Reserved	
42	Reserved	
43	Test Stuck Interrupt	Turn off interrupts then verify no 8259's interrupt mask register is on. Test 8259 Force an interrupt and verify the interrupt occurred.
44	Reserved	
45	Reinit serial port	Reinitialize Preboot agent serial port
46	Reserved	
47	EISA Test	If EISA non-volatile memory checksum is good, execute EISA initialization. If not, execute ISA tests and clear EISA mode flag.
48	Reserved	
49	Size Memory	Size base memory from 256K to 640K and extended



<b>Award POST Codes</b>		
<b>Code</b>	<b>Name</b>	<b>Description</b>
		memory above 1MB.
4A	Reserved	
4B	Reserved	
4C	Reserved	
4D	Reserved	
4E	Init APIC	Initialize APIC and set MTRR
4F	Reserved	
50	USB init	Initialize USB controller
51	Reserved	
52	Memory Test	Test all memory of memory above 1MB using Virtual 8086 mode, page mode and clear the memory
53	Reserved	
54	Reserved	
55	CPU display	Detect CPU speed and display CPU vendor specific version string and turn on all necessary CPU features
56	Reserved	
57	PnP Init Display	PnP logo and PnP early init
58	Reserved	
59	Setup Virus	Setup virus protect according to Protect Setup
5A	Reserved	
5B	Awdflash Load	If required, will auto load Awdflash.exe in POST
5C	Reserved	
5D	Onboard I/O	Init Initializing onboard superIO
5E	Reserved	
5F	Reserved	
60	Setup enable	Display setup message and enable setup functions
61	Reserved	
62	Reserved	
63	Initialize Mouse	Detect if mouse is present, initialize mouse, install interrupt vectors.
64	Reserved	
65	PS2 Mouse special	Special treatment to PS2 Mouse port
66	Reserved	
67	ACPI init	ACPI sub-system initializing
68	Reserved	

<b>Award POST Codes</b>		
<b>Code</b>	<b>Name</b>	<b>Description</b>
69	Init Cache	Initialize cache controller
6A	Reserved	
6B	Setup	Enter setup check and auto configuration check up
6C	Reserved	
6D	Initialize Floppy	Initialize floppy disk drive
6E	Reserved	
6F	FDD install	Install FDD and setup BIOS data area parameters
70	Reserved	
71	Reserved	
72	Reserved	
73	Initialize Hard Drive	Initialize hard drive controller
74	Reserved	
75	Detect HDD	IDE device detection
76	Reserved	
77	Detect serial ports	Initialize serial ports.
78	Reserved	
79	Reserved	
7A	Detect parallel ports	Initialize parallel ports.
7B	Reserved	
7C	HDD Write Protect	HDD check for write protection
7D	Reserved	
7E	Reserved	
7F	POST error check	Check POST error and display them and ask for user intervention
80	Reserved	
81	Reserved	
82	Security Check	Ask password security.
83	Write CMOS	Write all CMOS values back to RAM and clear screen.
84	Display PNP	Display PNP devices
85	USB Final Init	Final USB initialization
86	Reserved	
87	Reserved	
88	Reserved	
89	Setup ACPI tables	Setup ACPI tables

<b>Award POST Codes</b>		
<b>Code</b>	<b>Name</b>	<b>Description</b>
8A	Reserved	
8B	Option ROM Detect	Scan for Option ROMs
8C	Reserved	
8D	Enable Parity Check	Enable Parity Check
8E	Reserved	
8F	IRQ12 Enable	Enable IRQ12 if mouse present
90	Reserved	
91	Reserved	
92	Reserved	
93	Boot Medium Read	Detect and store boot partition head and cylinders values in RAM
94	Final Init	Final init for last micro details before boot
95	NumLock	Set NumLock status according to Setup
96	Boot Attempt	Set low stack Boot via INT 19h.
C0	Base CPU test	Read/Write CPU registers
C1	Memory Presence	Base memory detect
C2	Early Memory	Board Initialization
C3	Extend Memory	Turn on extended memory, cache initialization
C4	Special Display	First display initialization
C5	Early Shadow	Early shadow enable for fast boot
C6	Cache presence	External cache size detection
CF	CMOS Check	CMOS checkup
B0	Spurious	If interrupt occurs in protected mode.
B1	Unclaimed NMI	If unmasked NMI occurs, display Press F1 to disable NMI, F2 reboot.
BF	Program MCP	To program chipset from defaults values
E1-EF	Setup Pages	E1- Page 1, E2 - Page 2, etc.
FF	Boot	

Table 7. NVMM POST Codes

<b>NVMM POST Codes</b>		
<b>Code</b>	<b>Name</b>	<b>Description</b>
0F0h		Identify HW in the system
0F1h		Register the slam tables
0F2h		Early SLAM table
0F3h		COM port initialization
000h		Initialize the hardware devices
001h		Override input parameters, etc. before QUERY
004h		Query the hardware devices
008h		Read SPD & fill in arrays
00Ch		ROM table pointer
010h		Initialize the Memory Controller
011h		Program the PLLs
012h		Query after memory PLL has been set
013h		Set Dynamic SPD values
014h		Load MemInfoStruct
015h		Load the DIMM geometry (using SPD)
016h		Prepare MRS variables
017h		Probe memory geometry
018h		PROD_C: PROD f/ Calculated ref manuals
019h		PROD_D: PROD w/ Discrete assembly programming
01Ah		PROD_E: PROD w/ Expandable criteria
01Bh		Send MRS/EMRS configuration cycles
01Ch		Overvoltage handling
01Dh		PROD_F: PROD Final - after MRS/EMRS
020h		PCI Express Initialization
030h		Load Spread Spectrum tables
040h		Set Top-Of-Memory registers
044h		Late SLAM table
048h		Previous Power State SLAM table
04Ch		Hardware Workarounds
050h		Restore, and exit NVMM
054h		Memory Test

<b>NVMM POST Codes</b>		
<b>Code</b>	<b>Name</b>	<b>Description</b>
0FEh		ERROR handler
0FFh		End of Table
0FFh		Invalid APIC ID
0FEh		CPU Identify/Init failed
0FDh		North Bridge not supported
0FCh		South Bridge not supported
0FBh		No DIMMs present
0FAh		Invalid DIMM types, SDR/DDR
0F9h		Different voltage levels
0F8h		Invalid REFRESH Rate
0F7h		Invalid memory geometry
0F6h		Slam Engine error
0F5h		Memory Test Error
0F4h		Link Training timeout